

**GUIDANCE FOR
TRANSPORTING
AMMONIA
BY RAIL
2007**



**GUIDANCE FOR
TRANSPORTING
AMMONIA
BY RAIL**

SECOND EDITION

(First Edition 2005)

Copyright 2007 EFMA

EFMA
European Fertilizer Manufacturers
Association

Avenue E. van Nieuwenhuysse 4
B-1160 Brussels
Belgium

CONTENTS

1. INTRODUCTION	6
2. PROPERTIES AND CLASSIFICATION OF AMMONIA	
2.1 General Characteristics	6
2.2 Physical Properties of Ammonia	7
2.3 Chemical Properties of Ammonia	8
2.4 Health Hazards of Ammonia	8
2.5 Fire Hazard	10
2.6 Stress Corrosion Cracking	10
2.7 Classification and Proper Shipping Names	11
3. DESIGN AND CONSTRUCTION OF RAILWAY TANK CARS (RTCS)	
3.1 Application and Regulations	13
3.2 Design of RTCs	14
3.3 Materials of Construction	15
3.4 RTC Valves, Fittings and Couplings	16
3.4.1 Valves and Fittings	16
3.4.2 Couplings	20
3.5 Initial Testing of RTCs	21
4. DANGEROUS GOODS MARKING AND LABELLING	
4.1 Dangerous Goods Identification	23
4.2 Warning Plates	25
4.3 Substance Name and Maximum Load Identification	25
5. RECOMMENDATIONS FOR CONTRACTING AND MAINTENANCE OF RTCS	
5.1 Contracting RTCs	28
5.2 Maintenance Responsibilities	28
5.3 Periodic Testing	29
5.4 Purging with Nitrogen	29

6.	PERSONAL PROTECTIVE CLOTHING AND SAFETY EQUIPMENT	30
7.	LOADING AND UNLOADING OPERATIONS	
7.1	Requirements for Loading and Unloading	31
7.1.1	Recommendations for the Loading/Unloading Area	31
7.1.2	Equipment for the Loading/Unloading Station	33
7.1.3	Loading/Unloading Arm	33
7.1.4	Earthing	35
7.1.5	Emergency Equipment	36
7.2	Operator Training and Safety	37
7.2.1	Operator Training	37
7.2.2	Operating Instructions	37
7.2.3	Operator Safety	38
7.3	Loading Operation	38
7.3.1	Checklists	38
7.3.2	Suitability of the RTC	38
7.3.3	Purging	39
7.3.4	Filling Weight and Overfilling	39
7.3.5	Checks and Actions Before Loading	40
7.3.6	Checks and Actions During Loading	41
7.3.7	Checks and Actions After Loading	41
7.4	Unloading Operation	42
7.4.1	Checks and Actions Before Unloading	42
7.4.2	Checks and Actions During Unloading	42
7.4.3	Checks and Actions After Unloading	42

8.	TRANSPORTATION	
8.1	Safety Responsibilities	43
8.2	Obligations of the main participants	44
8.2.1	Consignor	44
8.2.2	Carrier	44
8.2.3	Consignee	45
8.3	Obligations of the Other Participants	45
8.3.1	Filler	45
8.3.2	Operator	46
8.3.3	Railway infrastructure manager	46
8.4	Safe Transport of Ammonia by RTCs	46
8.4.1	General	46
8.4.2	Safe Transport of Ammonia by RTCs	47
9.	AUDITS	
9.1	Safety and Quality Assessment Scheme	47
9.2	Internal Audits	48
10.	EMERGENCY RESPONSE	
10.1	Behaviour of Ammonia on Loss of Containment	48
10.2	Protection of the Surrounding Communities	49
10.3	Limiting the Release	49
10.4	Limiting the Vaporisation	50
10.5	Dissolving Ammonia in Water	50
10.6	Lowering the Concentration of Ammonia Gas/Vapour in Air	50
10.7	Fire Fighting Measures	50
10.8	Emergency Measures	51
10.9	Additional Information on Emergency Response	51
10.9.1	Emergency Plan at Loading/Unloading Sites	51
10.9.2	System of Reciprocal Assistance in Transport Emergencies	52
10.10	Incident Information Sharing	53
10.10.1	Rapid Alert System	53
10.10.2	Accident fact sheets	53

11. QUESTIONS AND ANSWERS	53	
12. REFERENCES	56	
ANNEX 1	Ammonia Rail Transport Accident Analyses	57
ANNEX 2	Abbreviations	60
ANNEX 3	Nomograph to show some properties of Ammonia	61
ANNEX 4	Methods used to mitigate the consequences of a loss of containment	62
ANNEX 5	Example of a checklist	67
ANNEX 6	Glossary of terms used	68
ANNEX 7	Special checking requirements before and after the filling of class 2 products (e.g. ammonia) referred to in RID 4.3.3.4.	71

Disclaimer

This publication has been prepared by the member companies of the European Fertilizer Manufacturers Association (EFMA). Neither the Association, any individual member company nor any individual representative of the member company can accept liability for accident or loss attributable to use of the information given in this Booklet. Users of this Booklet are advised to consult the latest national and international regulations as these may have changed since its publication.

1. INTRODUCTION

This Guidance for the transport and handling of ammonia has been drawn up by the European Fertilizer Manufacturers Association (EFMA), with the help and expertise of members in order to ensure high safety standards in operations involving ammonia transport. The Guidance deals exclusively with the transport of anhydrous ammonia in rail tank cars (RTC).

The importance of ammonia rail transport for the European fertilizer and chemical producers is considerable. Every year more than 1,500,000 tonnes of ammonia are transported in Western Europe by rail. Ammonia is toxic and therefore a number of safety precautions are taken to ensure that the relevant operations are carried out safely.

EFMA has analysed ammonia rail transport accidents in Europe to get a clear understanding of their causes and consequences. This analysis showed that none of the accidents, injuries or casualties was due to the release of ammonia (*see Annex 1*). The purpose of this Guidance is to improve further the safe handling and transport of anhydrous ammonia throughout the European Union as part of EFMA's Product Stewardship programme [Ref. 12].

The transport of ammonia is subject to stringent national and international regulations [Ref. 1-4]. The recommendations made in this Guidance go beyond the requirements of these rules and it is recommended that all those involved in the handling and transport of ammonia adopt them as appropriate. Every user of this Guidance is advised to give due consideration to the specific circumstances of their installation and situation when applying this Guidance. No part of the Guidance should be applied or interpreted in such a way that conflicts with existing national and/or international regulations. In all cases, such legal requirements must always take precedence over any part of the Guidance.

This 2007 booklet is an updated version of the 2005 booklet. The updated text mainly relates to a revision of the RID [Ref 2].

2. PROPERTIES AND CLASSIFICATION OF AMMONIA

2.1 General Characteristics

Chemical formula:	NH ₃
Chemical name:	Ammonia, Anhydrous Ammonia
UN Number:	1005
CAS Number:	7664-41-7
Molecular weight:	17.03

At ambient temperature and atmospheric pressure, ammonia is an alkaline, colourless gas with a pungent and suffocating odour. Ammonia gas is very soluble in water. The gas is strongly irritant/corrosive to the skin, eyes and respiratory tract and has toxic properties. Ammonia gas condenses into a colourless liquid when cooled and compressed. The liquid can cause severe cold burns on contact with the skin.

2.2 Physical Properties of Ammonia

Table 1 [Ref 5.] summarises a number of common physical data.

Table 1 **PHYSICAL DATA**

Property	Liquid	Gas
Colour	Colourless	Colourless
Smell	Pungent	Pungent
Density (0°C, 101.3 kPa)	638.6 kg/m ³	0.7714 kg/m ³
Density (-33.43°C, 101.3 kPa)	682 kg/m ³	0.888 kg/m ³
Boiling point (101.3 kPa)	-33.43°C	
Melting point	-77.71°C	
Critical temperature	132.4°C	
Critical pressure	11.28 Mpa.	
Critical viscosity	23.90 x 10 ⁻³ mPa.s	
Specific Heat (10°C, 1 MPa)	4.67 x kJ/kg K	
Specific Heat (-33.4°C, 1MPa)	4.47 x kJ/kg K	
Heat of Vaporisation (101.3 kPa)	1370 k J/kg	
Heat of Solution (1:1 mol H ₂ O, 0°C)	30.69 kJ/mol NH ₃	

The temperature dependence of some of the properties is given in the nomograph in Annex 3 [Ref. 10].

Table 2 gives the effect of temperature on the solubility of ammonia in water [Ref. 13].

Table 2 **SOLUBILITY OF AMMONIA**

Temperature °C	Solubility in water, wt% NH ₃
10	40.0
20	34.2
30	28.5
40	23.7
50	18.5

It is important to note that when ammonia is absorbed in water without cooling, the solubility is limited to about 18% due to the temperature rise of the solution as a result of the vigorous exothermic reaction.

Table 3 summarises the change in density of liquid ammonia with temperature. [Ref.13]

Table 3 DENSITY OF LIQUID AMMONIA

Temperature °C	Density of Liquid Ammonia, kg/m ³
-33	682
-15	659
0	639
10	625
20	610
30	595
40	580
50	563
60	545
70	540

2.3 Chemical Properties of Ammonia

Ammonia is an alkaline gas. The pH of a 1% aqueous solution is approximately 11.7. Ammonia in contact with certain other chemicals including mercury, chlorine, iodine, bromine, calcium, silver oxide or hypochlorites can form explosive compounds.

Gaseous ammonia can react violently with nitrogen oxides and strong acids.

Ammonia is very corrosive to copper and copper containing alloys and therefore, equipment in contact with ammonia must be free of them.

2.4 Health Hazards of Ammonia

Ammonia is a potentially hazardous substance, although it occurs naturally as a result of many biological processes. It can produce acute effects on humans and animals. It has strong alkaline and hygroscopic properties, which cause a primary irritation or corrosion to damp tissue surfaces, such as the eyes, respiratory system and skin.

Ammonia has a pungent odour; the odour threshold of ammonia is in the region of 5 ppm. Concentrations between 20-50 ppm in air are detectable by most people. This provides an adequate warning of its presence well below the hazardous concentration levels.

Gaseous ammonia affects the mucous membranes and the respiratory tract and severely irritates the eyes. Inhaling high concentrations may cause pulmonary oedema. High gas concentrations in the air may also cause blisters and chemical burns to the skin. The effects of exposure to various vapour concentrations are summarised in Table 4 [Ref. 14].

Table 4**EFFECT OF EXPOSURE TO AMMONIA**

Vapour Concentration ppm v/v	General effect	Exposure period
5	Odour detectable by some people.	–
25	–	Occupational exposure standard – long term, 8hr/TWA (MAC value in many countries).
35	–	Occupational exposure standard – short term, 15 min/TWA.
50-100	Irritation detectable by most people.	Tolerable for people unaccustomed to exposure for up to 2 hours. People accustomed to exposure can tolerate higher concentrations over the same period.
400-700	Immediate eye, nose and throat irritation.	½-1 hr exposure causes no serious damage although upper respiratory tract irritation may persist for 24 hr following 30 min exposure. Aggravation of existing respiratory problems could occur.
1000-2000	Severe coughing, severe eye, nose and throat irritation.	Damage to eyes and respiratory system could result in minutes if not treated quickly. 30 min exposure could produce very serious effects in people predisposed to severe respiratory problems.
3000-4000	Severe coughing, severe eye, nose and throat irritation.	Could be fatal after 30 min. Estimated LC ₅₀ (derived from animal data) for 2 hr exposure in this region.
5000-12000	Respiratory spasm. Rapid asphyxia.	Fatal within minutes. Estimated LC ₅₀ (derived from animal data) for 30 min exposure in this region.

Liquid ammonia in direct contact with the skin freezes tissues on contact and causes chemical burns.

Threshold Limit Values.

The EU threshold values are:

TLV/15 min TWA: 50 ppm = 36 mg/m³

TLV/8 hr TWA: 20 ppm = 14 mg/m³

Note: Threshold Limit Values and terminology differ in different countries.

2.5 Fire Hazard

Ammonia gas is combustible, but it is very difficult to ignite. Experiments as well as observations during accidents have shown that in the case of a release of ammonia in the open air, the ammonia – air mixture is generally outside the flammability limits [Table 5, Ref. 5]. Therefore the risk of a fire or explosion from an ammonia – air mixture outside buildings tends to be negligible. On the other hand, in confined spaces, the situation can be different and the risk of explosion should not be ignored.

Table 5 EXPLOSIVE LIMITS OF AMMONIA

Explosive limits in air (0°C, 101.3 kPa)	16 – 27 vol% NH ₃
Minimum auto ignition temperature to DIN 51749	651°C

In EU and UN legislation ammonia is not classified as a flammable gas. (Note: in the Global Harmonization System it will be classified as category 2: flammable gas).

The auto-ignition temperature of ammonia in contact with hot steel is about 650°C.

The minimum ignition energy by spark is 680 MJ and 10,000 times higher than the ignition energy of hydrogen and 1000 times higher than for natural gas.

2.6 Stress Corrosion Cracking

Stress corrosion cracking (SCC) is a phenomenon which can occur in metals exposed to a combination of stress and corrosive environment.

Liquid ammonia in the presence of oxygen can cause SCC in carbon steels.

The potential problem of SCC increases with increasing yield strength of the plate material, increasing strength of the weld metal and the local hardness in the welds.

The stress levels required to initiate SCC are high and are not experienced during normal operation. However residual welding stress levels together with the applied stress can be enough to initiate SCC if oxygen is present in sufficient quantities.

Ammonia as produced contains no oxygen, but air can get in when it is being transferred from manufacturer to user.

Tanks for transporting liquid ammonia can be susceptible to stress corrosion cracking if oxygen is present in sufficient quantity. Therefore the ingress of air into the tank must be prevented and tanks must be purged with nitrogen when commissioned for ammonia transport.

The Institute for Energy Technology, Kjeller, Norway [Ref. 15] carried out an extensive research programme on stress corrosion cracking, sponsored by several European ammonia producers. The results of their research show that the presence of water inhibits the formation and the growth of SCC.

Figure 1 shows the susceptibility of carbon-manganese steel to SCC in ammonia with different oxygen and water contents at a uniform temperature of 18°C.

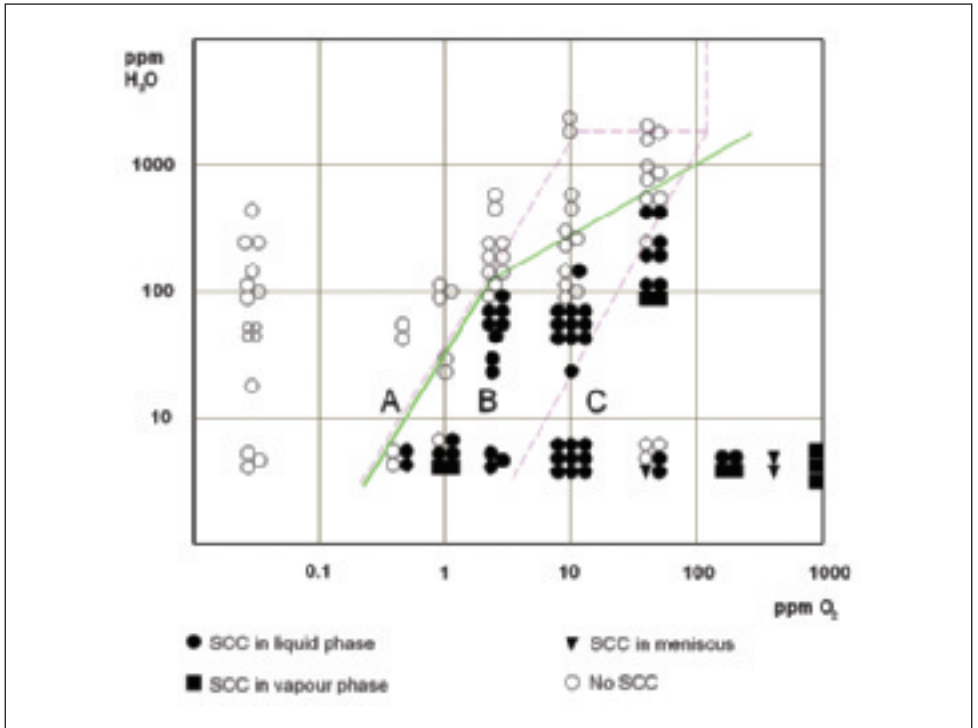

Figure 1 The effect of Oxygen and Water on Stress Corrosion Cracking of Mild Steel in Liquid and Vaporous Ammonia [Ref. 15]

The full drawn line in the graph represents the borderline for SCC in these experiments. Above this line no SCC was detected in the experiments.

Therefore it is recommended to add at least 0.1% wt water to the liquid ammonia before transport.

If a customer insists on receiving ammonia without water addition, take special care to ensure that the tank of the rail tank car (RTC) is free of traces of oxygen.

2.7 Classification and Proper Shipping Name

In the UN classification system for transport, anhydrous ammonia and strong solutions of ammonia are classified as toxic gas of Division 2.3, falling in Class 2.

Dilute solutions fall in Class 8, corrosive substances. Table 6 summarises the relevant particulars.

The UN transport regulations specify a proper shipping name for all dangerous substances. This also applies to mixtures and solutions. The proper shipping name to be

filled in on documents is the name in capital letters in the column “Name and description” as shown in Table 6 below.

For ammonia and ammonia solutions the following entries apply [Ref. 2]:

Table 6 UN TRANSPORT CLASSIFICATION AND LABELLING

UN no.	Name and description	Class	Labels	Tank code	Transport category	Hazard identification number
1005	AMMONIA, ANHYDROUS	2	2.3+8(+13)	PxBH (M)	1	268
3318	AMMONIA SOLUTION, relative density less than 0.880 at 15°C in water, with more than 50% ammonia	2	2.3+8(+13)	PxBH (M)	1	268
2073	AMMONIA SOLUTION, relative density less than 0.880 at 15°C in water, with more than 35% but not more than 50% ammonia	2	2.2(+13)	PxBN (M)	3	20
2672	AMMONIA SOLUTION, relative density between 0.880 and 0.957 at 15°C in water, with more than 10% but not more than 35% ammonia	8	8	L4BN	3	80

Note:

For the UN number 2073 the test pressure and the mass of contents are different for 35-40% and 40-50% solutions.

For UN 3318 the test pressure and the mass of contents have to be calculated based on the concentration and partial pressure at 55°C for tanks with thermal insulation, or 65°C without thermal insulation.

All requirements for UN 1005 and 3318 are the same except the test pressure and mass of contents. This means that even when the ammonia product contains a few percent water it can be treated as AMMONIA ANHYDROUS. (for ammonia the partial pressure is the highest and the density the lowest).

Ammonia without any water and ammonia with water (typically up to 0.5%) are both classified as UN 1005:

AMMONIA, ANHYDROUS;
 AMMONIAK, WASSERFREI;
 AMMONIAC ANHYDRE;
 AMMONIAK, WATERVRIJ.

3. DESIGN AND CONSTRUCTION OF RAILWAY TANK CARS

3.1 Application and Regulations

Railway Tank Cars (RTCs) for transporting anhydrous ammonia must meet the requirements of the following regulations with regard to their design and construction:

- Any national provisions or the regulations of the respective railway company for national transportation;
- Any international provisions, such as the Regulations concerning the International Carriage of Dangerous Goods by Rail (RID) for international transportation.

It is important that the most recent versions of the relevant regulations are consulted before the design and construction of RTCs is undertaken.

The design, materials and construction should be selected to minimise the potential for stress corrosion cracking. As described in Section 2.6 the risk of SCC increases with increasing yield strength of the plate material, increasing strength of the weld metal and the local hardness in the welds. These factors should be taken into account.

The required type of tank is given in code form in the RID regulations. Anhydrous ammonia has been allocated a tank code of **PxBH** with special provisions **TM6**, **TT8** and **TE 25**.

P = RTC for liquefied gases or gases dissolved under pressure.

x = value of the relevant minimum test pressure in bar according to the table in RID 4.3.3.2.5.

B = RTC with bottom filling or discharge openings with 3 closures.

H = hermetically closed RTC. (See RID 1.2.1 or Annex 6 for the definition of hermetically closed).

TM6: RTCs intended for the carriage of liquefied or refrigerated liquefied gases shall be marked with an unbroken orange band, about 30 cm wide, encircling the shell at mid-height.

TT8: RTCs approved for the carriage of UN 1005 AMMONIA, ANHYDROUS and constructed of fine-grained steel with a yield strength of more than 400 N/mm² in accordance with the material standard, shall be subjected to magnetic particle inspections to detect surface cracking at each periodic test according to RID 6.8.4.

For the lower part of each shell at least 20% of the length of each circumferential and longitudinal weld shall be inspected, together with all nozzle welds and any repair or ground areas.

TE25: Shells of tank-wagons shall also be protected against overriding of buffers and derailment or, failing that, to limit damage when buffers override, by at least one of the following measures:

- 1) Measures to avoid overriding. This is done by having installed a device located above every buffer to protect against the overriding of buffers.

- 2) Measures to limit damage when buffers override. This can be done by increasing the wall thickness of the tank ends or using other material with a greater energy absorption capacity.
- 3) Sandwich cover for tanks covering the entire area of the tank ends and with a specific energy absorption of at least 22 kJ.
- 4) Protective shield at each end of the wagon.

3.2 Design of RTCs

The holding volumes of RTCs commonly used are 50 to 110 m³.

Shells shall be designed and constructed in accordance with the requirements of a technical code recognised by the competent authority, in which the material is chosen and the wall thickness determined by taking into account the maximum and minimum filling and working temperatures.

Shells, their service and structural equipment, shall be designed to withstand the following without loss of contents:

- static and dynamic stresses in normal conditions of carriage
- prescribed minimum stresses at the test pressure as defined in the RID 6.8.2.1.15.



Figure 2 Typical example of an ammonia RTC showing the orange band, heat shield and identification plate

RTCs should be constructed with a support framework (under frame) between the two wheel bogies. EFMA recommends that RTCs in which the tank constitutes a self supporting member should not be used for the transportation of ammonia.

More special provisions for ammonia tank wagons have come into force from the 1st of January 2007. These concern measures to prevent the overriding of buffers and protection of tank ends (for details see TE25 and RID 1.6.3.27a).

Measures should be taken (See RID 6.8.2.1.7.) to protect the shells against the risk of deformation as a result of a negative internal pressure (vacuum). These measures include the choice of materials for the shells and the calculation of the wall thickness of the shell (RID chapter 6.8.2). RTCs should fulfil all the requirements of the RID regulations or the regulations that were applicable at the time of construction.

Any thermal insulation applied to the tank should consist of either:

- a sun shield covering not less than the upper third but not more than the upper half of the tank surface and separated from the shell by an air space at least 4 cm across; or
- a complete cladding of insulating materials, of adequate thickness.

The competent authority or a body designated by that authority shall issue a certificate for each type of RTC attesting that the prototype including fastenings, which it has inspected, is suitable for the intended purpose and meets the construction and equipment requirements of the RID regulations and the special conditions specified for the classes of substances carried. (RID 6.8.2.3.1)

Based on the design of the tank (see 3.2) it is possible to fit the tank with or without a safety valve. It is common practice and recommended to design the RTC in such a way that no safety valves are used.

A safety valve, if used, must be in conjunction with a bursting disc. This is part of the tank code **PxBH** (**H**: hermetically closed).

If RTCs are fitted with safety valves, a bursting disc shall be placed before the valves. The arrangement of the bursting disc and safety valve shall be such as to satisfy the competent authority. A pressure gauge or another suitable indicator shall be provided in the space between the bursting disc and the safety valve, to enable the detection of any rupture, perforation or leakage of the disc which may disrupt the action of the safety valve (see RID 6.8.2.2.10).

3.3 Materials of Construction

Materials of tank construction, including the coatings, valves, fittings, gaskets, etc. shall be suitable for anhydrous ammonia and shall fulfil all the requirements of the RID regulations and all national regulations when applicable.

All the materials, including those of components, which are in contact with the ammonia, shall be free from substances liable to react dangerously with it; to form dangerous compounds; to degrade the material properties; or to affect the quality of the ammonia.

In particular, copper or copper containing materials must not be used.

Shells shall be made of suitable metallic materials which shall be resistant to brittle fracture and to stress corrosion cracking between -20°C and +50°C. (RID 6.8.2.1.8)

3.4 RTC Valves, Fittings and Couplings

3.4.1 Valves and fittings

3.4.1.1 General description

Tanks have to be equipped with internal valves and typically with loading/unloading connections positioned on both sides of the tank.

The number of pieces of equipment on the RTC must be kept to a minimum.

Figures 3 and 4 show a typical arrangement of a RTC for carrying anhydrous ammonia.

Figure 5 shows an explanatory model of a typical arrangement of hydraulically operated bottom valves. Figures 6 and 7 show diagrams of a typical hydraulic bottom valve and a mechanical bottom valve respectively.

3.4.1.2 More detailed information from RID

In order to avoid any loss of contents in the event of damage to the external fittings (pipes, lateral shut-off devices), the internal stop-valve and its seating shall be protected against the danger of being wrenched off by external stresses or shall be designed to resist them. The filling and discharge devices (including flanges or threaded plugs) and protective caps (if any) shall be secured against any unintended opening.

Items of equipment shall be so arranged as to be protected against the risk of being wrenched off or damaged during carriage or handling. They shall exhibit a suitable degree of safety comparable to that of the shells themselves, and shall be compatible with the substances carried.

The closing device at the end of each pipe may be a screw-threaded plug, a blank flange or an equivalent effective device. This closing device shall be sufficiently tight so that the substance is contained without loss. Measures (like a drain valve) shall be taken to enable the safe release of pressure in the discharge pipe before the closing device is completely removed (RID 6.8.2.2.2).

The leakproofness of the closures of the tanks shall be checked by the filler after the tank is filled (RID 4.3.2.3.3).

All openings, other than those accommodating safety valves and closed bleed holes shall, if their nominal diameter is more than 1.5 mm, be equipped with an internal shut off device (RID 6.8.3.2.4)

Each bottom-filling or bottom-discharge opening shall be equipped with at least three mutually independent closures, mounted in series, comprising:

- An internal stop-valve, i.e. a stop-valve mounted inside the shell or in a welded flange or companion flange;
- An external stop-valve or equivalent device, one at the end of each pipe;
- A closing device at the end of each pipe, which may be a screw threaded plug, a blank flange or an equivalent device (RID 6.8.2.2.2).

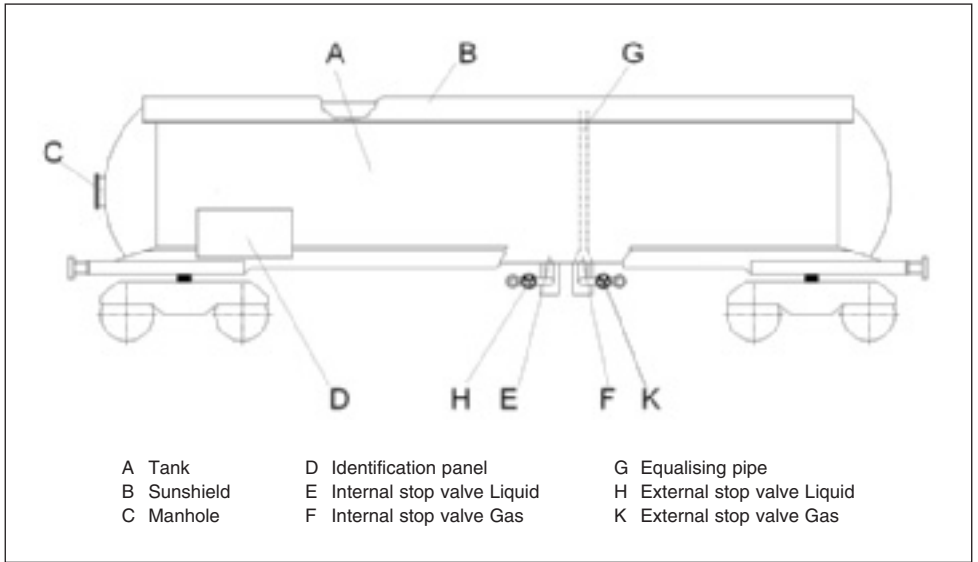

Figure 3 Diagram of a typical RTC (side view)

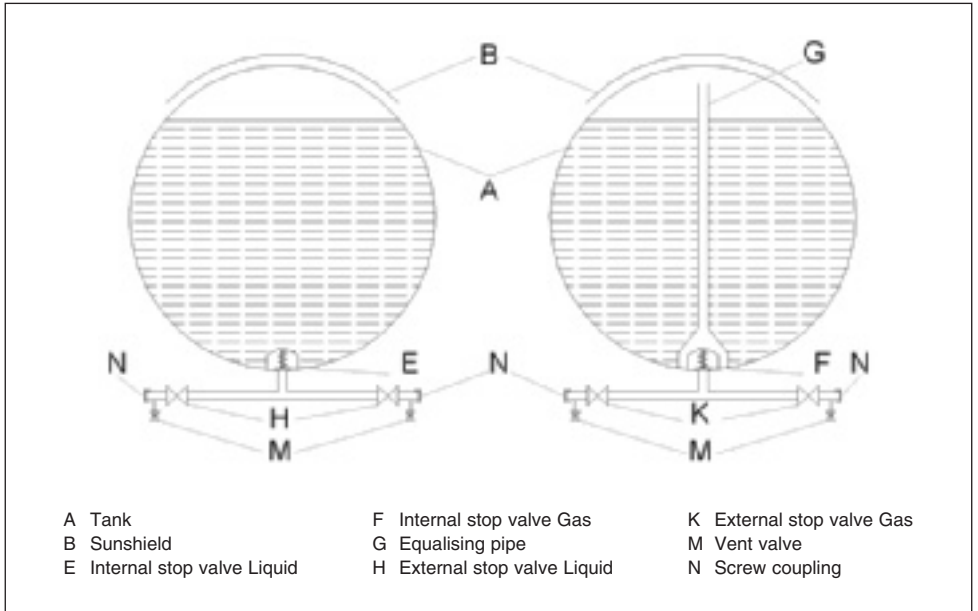

Figure 4 Diagram of a typical RTC (cross view)

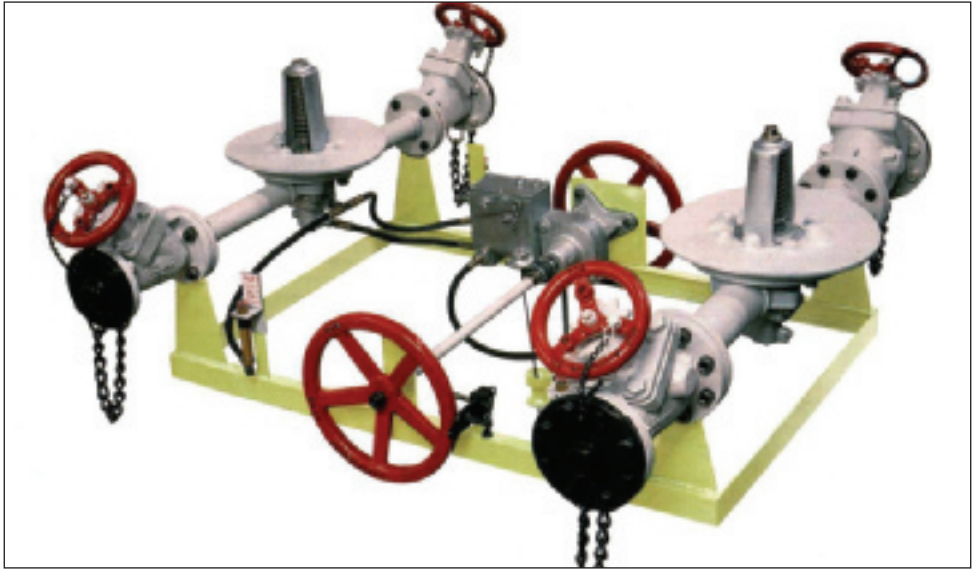

Figure 5 Explanatory model showing a typical arrangement of hydraulically operated bottom valves

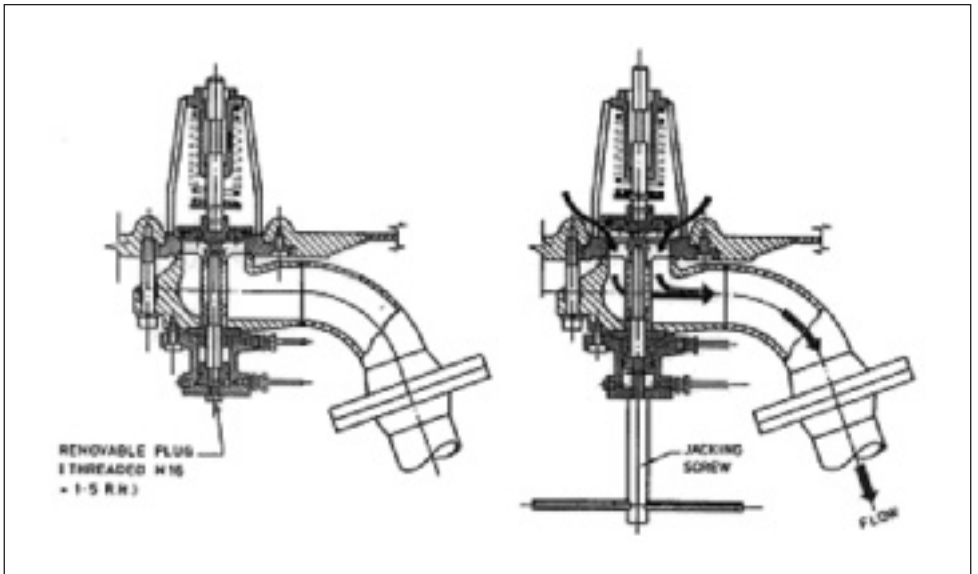

Figure 6 Diagram of a typical hydraulic bottom valve

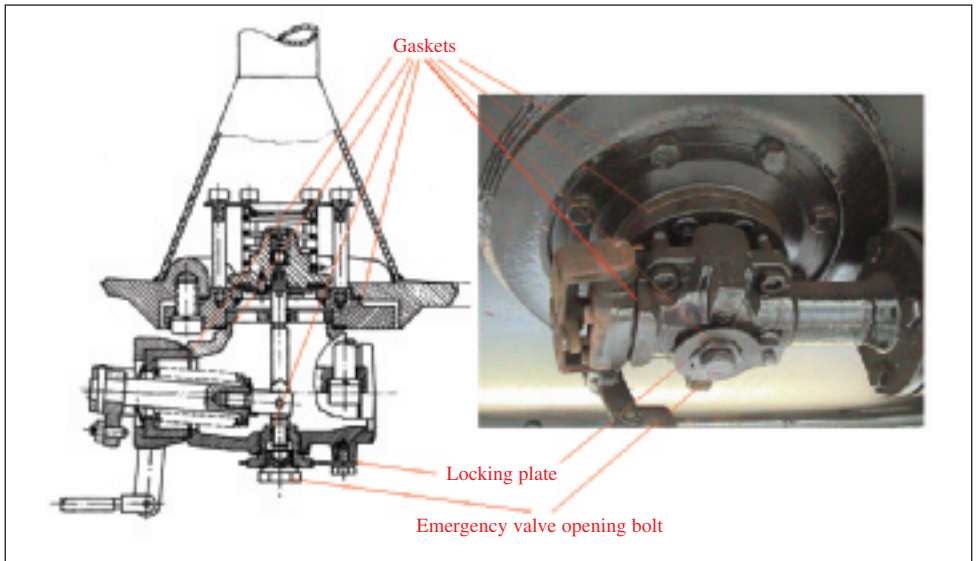

Figure 7 Diagram of a typical mechanical bottom valve

The internal stop-valve shall be operable from below. Its setting – open or closed – shall, so far as possible in each case, be capable of being verified from the ground. Internal stop-valve control devices shall be so designed as to prevent any unintended opening through impact or inadvertent act.

The internal shut-off device shall continue to be effective in the event of damage to the external control device.

The position and/or direction of closure of shut-off devices shall be clearly apparent.

Filling and discharge openings of tanks shall be equipped with an instant-closing internal safety device which closes automatically in the event of an unintended movement of the shell. It shall also be possible to operate the closing device by remote control (RID 6.8.3.2.3).

The leakproofness of the service equipment shall be ensured even in the event of the RTC or tank container overturning (RID 6.8.2.2.1).

Gaskets shall be made of a material compatible with the substance carried and shall be replaced as soon as their effectiveness is impaired, for example as a result of ageing (RID 6.8.2.2.1).

Gaskets ensuring the leakproofness of fittings needing to be manipulated during normal use of the tank shall be so designed and arranged that manipulation of the fittings in which they are incorporated does not damage them (RID 6.8.2.2.1).

3.4.2 Couplings

Many different types of couplings are currently used for loading/unloading ammonia: screw couplings, flange-type couplings and dry break couplings. The most commonly used screw coupling and flange-type coupling are described below.

For ease of product transfer, EFMA strongly recommends a reduction in the number of coupling types used on RTCs and loading/unloading stations. EFMA favours the use of screw couplings.

European rail transport regulations (RID) require that the extremities of each transfer line of the tank (one for the gas and one for the liquid phases, on both sides of the tank) are equipped with closing devices in addition to the block valves. These may be threaded caps, blind flanges, or an equivalent device. The caps or flanges and their protective covers must be secured against any unintended opening (*see Figure 8*).

The couplings of the RTC and the loading/unloading arm must be exactly compatible (same design) to prevent leakages during product transfer.

The coupling device is connected to the connection pipe of the RTC with a flanged type connection. To prevent any damage to the gasket, this assembly must never be removed.



Figure 8 The screw-coupling with its protective cover ready for transport. Tie-raps are used to warn against unauthorised opening

It is important to verify the compatibility of the couplings with those of the “fixed” installations, prior to sending ammonia RTCs to suppliers or clients for loading or unloading. If necessary a suitable adapter has to be used.

The most commonly used coupling devices are:

Screw-couplings of WECO® type (Figure 9):

In this case, the RTC is equipped with “female” half-joints, generally of 3” and 2” diameter for the liquid and gas phases. The half-joint has an external thread (*see Figure 10*), which can be from the ACME or ISO type, and includes a gasket made of synthetic material compatible with ammonia (e.g. Chloroprene 65). The joint is closed, during transport, by a threaded cap blocked by contact with the gasket. Symmetrically, the loading/unloading arms are equipped with “male” half-joints, holding a nut with an internal thread, of the same type. The tightness of the coupling is obtained through the gasket, and a metal-metal contact between the half-joints obtained after tightening.

The coupling is made by screwing the nut, by hand in a first step, and with a bronze (or “rubber”) hammer in a second step, until the male half-joint comes in contact with the gasket.

These standard couplings can be fitted with a ¼” ball valve, which allows the release of residual pressure which can be found in the connection pipe when the bottom or block valves are not 100% tight.

It is always necessary to release the pressure resulting from the presence of ammonia carefully before unscrewing the cap.

Couplings with flange assemblies:

A connection pipe (*see Figure 22 on page 36*) is fixed onto the external flange of each block valve, the other end of which is also equipped with a standard flange (DIN 80). During transport, the line is closed with a blind flange, fixed by 8 bolts. For loading/unloading operations, the blind flanges are removed on the side facing the “fixed” installations and the flange of each arm end is assembled with the corresponding one of the tank.

This type of coupling requires the person in charge of the assembly to pay attention to the condition of the gasket which is used. If it is damaged, the tightness of the flange connections of both the liquid and gas circuit during the transfer of the ammonia can be insufficient, and a leakage can occur. It is thus essential that these persons have received adequate instructions for making/breaking flange connections and that they are made aware of the risks of improper gasket installation.

3.5 Initial Testing of RTCs

Shells and their equipment shall undergo an initial inspection, either together or separately, before being put into service. This inspection shall include (RID 6.8.2.4.):

- a check of conformity to the approved prototype;



Figure 9 Screw couplings of the WECO type



Figure 10 ACME type WECO 6000 psi Screw coupling

- a check of the design characteristics;
- an examination of the internal and external conditions;
- a hydraulic pressure test at the pressure indicated on the plate and specified in the RID 6.8.2.5.1.
- a leakproofness test and a check of satisfactory operation of the equipment.

The materials of every welded shell shall be tested according to the method described in the RID 4.3.3.2.1, 4.3.3.2.4 and 6.8.5.

The minimum test pressures for ammonia are:

- 2.6 MPa (26 bar) for tanks with thermal insulation
- 2.9 MPa (29 bar) for tanks without thermal insulation

The capacity of each shell shall be determined, under the supervision of an expert approved by the competent authority, by weighing or volumetric measurement of the quantity of water which fills the shell; the measurement of shell capacity shall be accurate to within 1%. Determination by a calculation based on the dimensions of the shell is not permitted (RID 6.8.3.4.4).

For periodic testing see chapter 5.3.

4. DANGEROUS GOODS MARKING AND LABELLING

4.1 Dangerous Goods Identification

The RTCs intended for the carriage of liquefied or refrigerated liquefied gases shall be marked with an unbroken orange band, about 30cm wide, encircling the shell at mid-height (*see Figure 2*).

Identification is by a UN-number plate.

The UN-number plate has the number 268 on the upper part. This identifies the nature of the hazard.

The number 1005 on the lower part is the identification number for ammonia.

The plate background is coloured orange. It is recommended that the plate is made out of metal with stamped letters so that the plate can be read when the paint has disappeared.

The numbers in 268 have the following meanings (*see Figure 11*):

2 = gas	8 = corrosive substance
6 = toxic substance	1005 = ammonia

The identification label must be checked by the responsible operator. If the identification label is missing, damaged or in bad conditions it shall be changed.

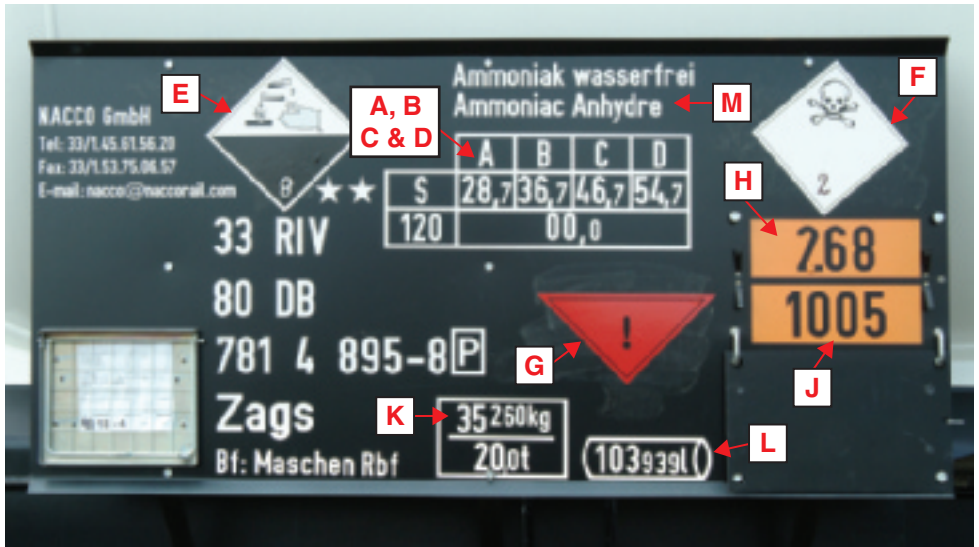

A, B, C and D⁽¹⁾ Track charge

- A ammonia load in tonnes for a line category A (max. axle pressure is 16 tes, total weight is 64 tes)
- B ammonia load in tonnes for a line category B (max. axle pressure is 18 tes, total weight is 72 tes)
- C ammonia load in tonnes for a line category C (max. axle pressure is 20/20.5 tes, total weight is 80/82 tes)
- D ammonia load in tonnes for a line category D (max. axle pressure is 22.5 tes, total weight is 90 tes)

E Danger label corrosive substance

F Danger label toxic gas

G Danger sign shunt carefully

H Hazard identification number (Toxic gas, corrosive)

J UN four-figure identification number

K Tare weight

L Actual tank Volume

M Proper shipping name: Ammoniak wasserfrei; Ammoniac Anhydre

⁽¹⁾ Note: The ammonia load may never exceed the volume (L) multiplied by 0.53. The smallest number is placed on the side board.

Figure 11 Dangerous goods marking and labelling of a RTC containing ammonia

4.2 Warning Plates

All old hazard labels and warning plates which do not refer to the product to be transported, should be removed before transportation. If the hazard labels are missing they must be added, as follows:

- Danger label 2.3 Toxic gas: white label with skull. The number 2 is written on the bottom of the label (*see Figure 12*)
- Danger label 8 “corrosive”: black/white label. The number 8 is written on the bottom of the label (*see Figure 13*)
- Danger sign 13 “shunt carefully”: Red triangle with exclamation mark (*see Figure 14*)

The RTC must be provided with warning plates on both sides.

4.3 Substance Name and Maximum Load Identification

Comparison of the product name on the tag with the details given in the loading papers ensures that the correct product has been loaded or can be loaded. In addition, the customer must check that the product is correct before emptying the tank.

RTCs should have outer seals at the discharge and other openings, for reasons of quality assurance.

RTCs should only be loaded with the substance indicated on the hazard labels and documentation.

The maximum filling depends on the type of RTC and the railway route. The RTC can be loaded to the maximum filling weight, to be calculated by multiplying the actual tank volume written on the RTC (*see L in Figure 11*) by 0.53 kg/l, and not higher than the maximum predetermined loading limit of the railway route (*see Figure A, B, C and D in Figure 11*). This will be given by the railway transport company. If the maximum filling weight of the railway route is less than the maximum filling weight of the RTC, the limit of loading weight is the lower value.

The date of the next tank inspection (*see Figure 15*) should be checked. The inspection date is written on both sides of the tank casing. The date of the next revision (*see Figure 16; railway engineering examination*) should also be checked. The latest revision date and the remaining time to the next revision are written on both sides on the RTC chassis.



Figure 12 Danger label 2.3 Toxic gas



Figure 13 Danger label 8 Corrosive

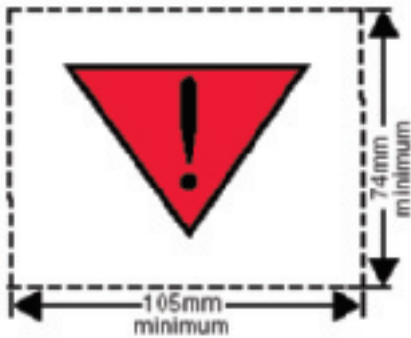

Figure 14 Danger sign 13 Shunt carefully

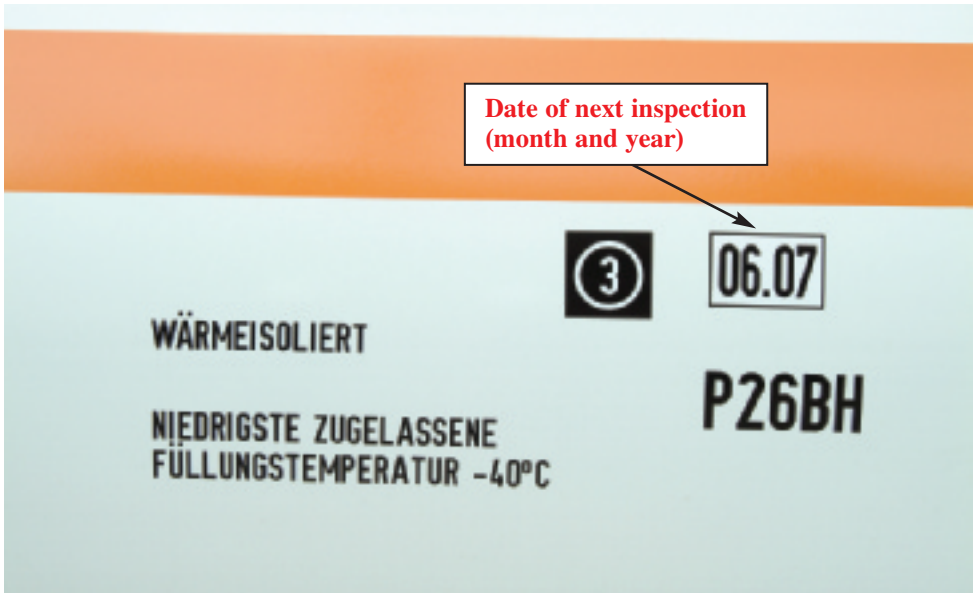

Figure 15 Date of next inspection

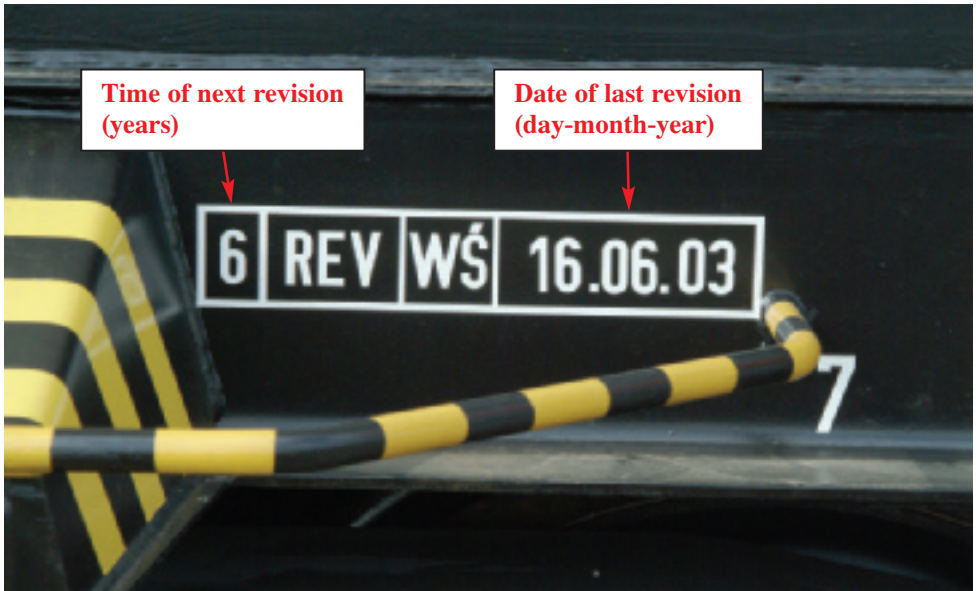

Figure 16 Time of next revision (in years) and date of last revision

5. RECOMMENDATIONS FOR CONTRACTING AND MAINTENANCE OF RTCs

5.1 Contracting RTCs

RTCs for ammonia are procured by the loading company's wagon management department.

Quotations are obtained from certified companies offering suitable pressurised gas RTCs for ammonia.

Requirements and specifications to be taken into account for contracting RTCs:

- RTCs for pressurised gases must have been specifically approved for the transport of ammonia
- Technically approved by the railway administration
- Technically approved by an officially recognised testing and certification organisation
- Valid approval according to RID regulations
- Valid approval for tank and chassis
- Approved valves and fittings (changes made by the user should be made in accordance with the owner; these changes should also be part of a maintenance regime)
- Features specified by the customer, e.g. tank shell material, volume of pressurised tank, pressure rating of tanks, type of connections, etc.

When the RTCs are received by the filler:

- The technical condition of the RTC is checked according to a filler specific check list.
- All certificates of internal approval and external authority approval are checked.
- The tank, valves, fittings and connections (discharge pipe) are pressure tested for leaks.

5.2 Maintenance Responsibilities

According to RID regulations, the responsibility for maintaining the RTC in good condition and performing tests required by legislation rests with the owner. In case of leased RTCs technical supervision must be done in a competent RTC service centre. This maintenance comprises preventive maintenance, replacement of worn out parts and small repairs.

In the case of own RTCs for pressurised gas, the RTC service centre will carry out the duties of the owner and ensure that the tests demanded by legislation are performed. An independent surveyor appointed by the owner and approved by the competent authority, will be responsible for the technical approval of the tests specified by legislation.

In the case of leased RTCs for ammonia, the owner is responsible for performing the tests specified by legislation and for observing the specified test intervals. Overhauls of the chassis and the periodic tests on the tank will be inspected by the officially approved testing and certification organisation.

The test cycles of all RTCs used by the loading company will be monitored and will be logged in a computer system.

All RTCs are inspected when they leave the works. If any technical defects are found, they will either be repaired by the RTC service centre or returned to the owner for repairs if they are leased or if extensive repairs are necessary.

Repairs are the responsibility of the owner and may only be performed by competent workshops.

5.3 Periodic Testing

The periodic tests, which are the responsibility of the owner and are required by legislation, are defined in the RID regulations. Pressurised RTCs for ammonia have to be subjected to a hydraulic pressure test every 8 years (see RID 6.8.2.4.2.) and a leakproofness test every 4 years (see RID 6.8.2.4.3). The date and type of the most recent test performed must be marked on the plate. It should read “month, year” followed by a “P” when the test is the initial or a periodic test in accordance with RID 6.8.2.4.1. and 6.8.2.4.2, or “month, year” followed by an “L” when the test is an intermediate leakproofness test in accordance with RID 6.8.2.4.3.

An additional internal inspection and crack tests have to be performed every 8 years. RTCs used for ammonia and made of fine grid steel should be tested for SCC.

The chassis has to be overhauled every 4 or 6 years as indicated on the RTC. A voluntary annual inspection is recommended. For this purpose a (CEFIC/UIP) checklist can be found on <http://www.sqas.org/workshop/index.html>.

The loading company will inspect all RTCs at the beginning of the leasing period or when they are returned from external repairs and maintenance according to a loader specific checklist.

After repairs have been made all RTCs for pressurised gases will be pressure tested for leaks.

Copies of the tank record or all necessary documents shall be made available to the experts for tests, inspections and checks on the tanks. The tank record shall be retained by the owner or the operator. The tank record shall be maintained throughout the life of the tank.

5.4 Purging with Nitrogen

Purging of a RTC with nitrogen is necessary in the following situations:

- to remove air (oxygen) or other impurities from the tank prior to the use of the RTC for loading and transporting ammonia. This type of purging is required for:
 - newly hired RTCs,
 - RTCs that have been aerated for maintenance (e.g. for periodic tank inspection),
 - RTCs that have been used previously to transport products other than ammonia.

- to remove ammonia from the tank prior to the use of the RTC for transporting other products or prior to maintenance work on the tank itself. When access to the tank is necessary for maintenance or periodic inspection, the tank needs to be aerated after the nitrogen purge.

When RTCs need to be purged with nitrogen it is advised to purge to an oxygen level of 0.5% oxygen or less.

When ammonia gas needs to be purged from RTCs, the purge gas should always be taken to a safe location, which depends on the design and the facilities available at the location. In some cases the purge gas can be returned to the process facilities, other locations may have a flare system for the safe disposal of the purge gas.

During the purging the progress of the purging can be determined by analysing the purge gas stream.

A certificate of purging should be made out at the end of each purging operation.

6. PERSONAL PROTECTIVE CLOTHING AND SAFETY EQUIPMENT

The requirements for personal protective clothing and safety equipment will depend on the operations and potential hazards at the loading/unloading location.

A risk assessment should be carried out to identify the specific protective clothing and equipment to be used at each location taking account of the potential hazards and the activities. The risk assessment should consider the equipment mentioned below.

- Suitable safety footwear
- Full body overall or chemical protective suit
- Chemical protective apron or raincoat
- Safety helmet
- Goggles
- Face shield
- Chemical protective gloves
- Breathing mask equipped with ammonia absorbing filters/ fresh air supply
- Breathing apparatus.

The risk assessment may conclude that different protective clothing is required for different parts of the operation. For example a chemical protective suit and breathing mask may be stipulated during the actual connection/disconnection of the RTC and normal overalls may be acceptable at other times.

Also the risk assessment may conclude that certain protective clothing should be available in the area for unforeseen problems or emergency situations.

In addition, the following safety equipment should be available in the area for use in an emergency:

- Drench showers and eye-wash bottles should be available in a safe position, close to the loading/unloading area. They must be regularly inspected to ensure continued availability and good condition. Precautions should be taken to prevent freezing.
- Self-contained breathing apparatus suitable for escape purpose should be available for all operators present during the loading/unloading operation. They must be regularly inspected to ensure continued availability and good condition. All sets must be serviced and recharged immediately after use, no matter how short the duration.

7. LOADING AND UNLOADING OPERATIONS

7.1 Requirements for Loading and Unloading

Recommendations for loading/unloading are given below. It should be noted that there are possible situations where *liquid ammonia* is present in both the liquid *and/or* in the gas lines. *This can cause unsafe situations if nothing is expected to be present in these lines.*

7.1.1 Recommendations for the loading/unloading area

Recommendations and rules that apply for the loading/unloading area:

- Loading/unloading operations of RTCs should only take place in areas of the site specifically allocated for this kind of operation.
- The loading/unloading area should be marked for the presence of ammonia.
- The loading/unloading area should have a smooth, horizontal surface. The rail track of the loading/unloading station should be in the horizontal position.
- The loading/unloading rail track should not be part of a through going rail track but should be a side rail track.
- An interlock system on the railway should be available to prevent other trains entering the loading/unloading station during operations.
- Derailment devices should be used to prevent other RTCs entering the loading/unloading station (*see Figure 17*).
- The nearest rail track should be at a safe distance from the loading/unloading rail track.
- Precautions should be taken to prevent the RTC moving during loading/unloading.
- Mechanical haulage devices should be interlocked with the loading/unloading station to prevent the RTC moving during loading/unloading.



Figure 17 Derailment devices to prevent other RTCs from entering the loading/unloading station

- The nearest road should be at a safe distance from the loading/unloading rail track. Depending on the local situation, anti-collision protection might be necessary to safeguard against unwanted situations and mechanical damage.
- A safe distance of at least 15 m is recommended between ammonia filled RTCs in the loading/unloading area and buildings, equipment and reservoirs that can contain flammable/explosive substances.
- A safe distance of at least 25 m is recommended between the ammonia loading/unloading activities and the loading/unloading activities of flammable liquids or gases if such activities are performed simultaneously.
- There should be no openings to underground drainage systems, openings to buildings or, air intake openings of any air supply within at least 5 m of the direct loading/unloading area.
- The loading/unloading area should be situated at a reasonably safe distance from the site fence and from public roads.
- An illuminated windsock should be installed.

- A water supply point provided with a hose should be available to deal with small leakages.
- An acoustic and/or optical alarm system that can be activated from various places should be installed.
- Proper attention should be given to good house keeping to prevent unsafe situations.

7.1.2 Equipment for the loading/unloading station

The following items of equipment are recommended for the working platform of loading/unloading stations:

- A loading/unloading arm.
- Devices for leak detection.
- RTC pressure vent connections.
- A gas phase connection.
- An inert gas purge for loading/unloading arms.
- Safety equipment such as a water curtain/mechanical curtain, water sprinkling, eye flushing stations and emergency shower/diving pools.
- An emergency shutdown system to stop the loading/unloading operation.
- Systems to prevent overfilling (see Section 7.3.4).
- A device for monitoring the filling process.
- A rail hook (*see Figures 18, 19 and 20*) with melting fuse (to protect against external fire) or an electro-magnetic/electro-pneumatic or manual operated shut down system to close the bottom valves.
- A rail block against unintentional moving.
- All remote control valves should have a fail-safe function.
- The loading/unloading area should be classified according to ATEX-guidelines and the equipment of the station should be selected and marked accordingly.
- Copper and copper bearing alloys shall not be used as material in an ammonia containing environment.

7.1.3 Loading/Unloading arm

The loading/unloading arms are pipes connected with swivel joints (*see Figure 21*).

Spring systems balance the loading/unloading arm and hold the arm in the required position.

An interlock system prevents the valves of the loading/unloading arm from opening if there is no connection with the RTC.



Figure 18 Connection ring and cable between the rail hook and the bottom valve of the RTC for closure of the bottom valve upon movement of the RTC



Figure 19 Release rope for distant closure of the bottom valve via the release of the rail hook in case of emergencies



Figure 20 Rail hook, connected to the bottom valve cable, locked in the rails with manual release rope



Figure 21 Typical lay-out of a loading/unloading arm with screw couplings

The following equipment items are necessary parts of the loading/unloading arms:

- a shut-off valve,
- an arm for the liquid phase and an arm for the gaseous phase,
- a drain device on the filling arm,
- a switch for the stowed position of the loading arm.

Optional are:

- a nitrogen purge connection,
- a device to check the tightness and proper connection of the arms,
- an emergency release coupling (*see Figure 22*),
- a filter device in the liquid line.

7.1.4 Earthing

Although there is no need to earth during loading and unloading of ammonia for safety reasons, it is common practice to do so. In many cases earthing devices are already present because of the loading and unloading of other products at the site. If earthing is applied it is necessary to provide effective earthing during loading and unloading such as between the tank and the undercarriage and between the rail and the ground.

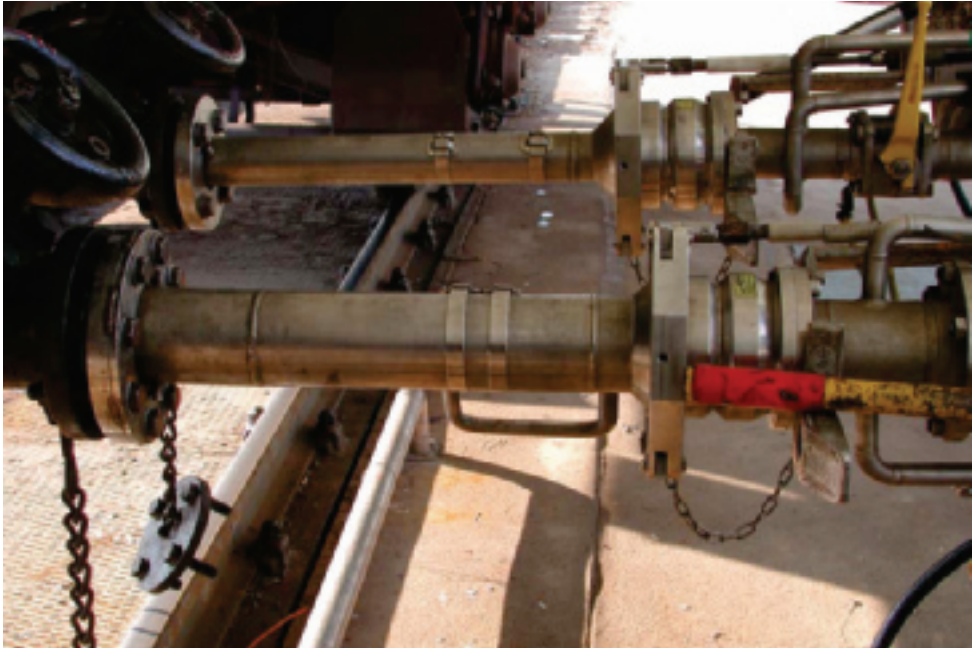

Figure 22 Flange loading/unloading arm with emergency release coupling

7.1.5 Emergency equipment

7.1.5.1 General recommendations

The loading/unloading station should be equipped with a remote shutdown system that can be used in an emergency situation. This remote system should close the bottom valves of the RTC and the emergency shut down valves of the loading/unloading arms.

The need for other emergency equipment in the loading/unloading area will depend on the specific hazards identified at each facility. The following items should be considered:

- A positive pressure breathing air supply to the control building in the direct vicinity of the loading/unloading station.
- An ammonia gas detection system around the perimeter of the station.
- A rail hook system for the valves of the railway cars.
- A flow monitoring and shutdown system to detect excessive 'flow' caused by pipe or connection failure.
- Dry drainage ditches and/or retaining tanks/bunds to contain spillages.
- Fire hydrants at various locations in the area so that a water supply will always be available, irrespective of the wind direction.

Alternative measures to mitigate loss of containment are:

- Water curtain systems
- Dynamic semi-confinement
- Yara-system

These alternatives are described in Annex 4.

7.2 Operator training and safety

7.2.1 Operator Training (Chapter 1.3 of RID)

The loading/unloading of liquid ammonia may only be performed by qualified operators who are specially instructed about their tasks.

In addition to normal process training, all operators responsible for loading/unloading of liquid ammonia shall receive instruction in the following:

- general requirements for the carriage of dangerous goods,
- special requirements from RID for class 2 substances related to ammonia,
- refresher training to take account of changes in regulations,
- the properties of ammonia and the behaviour of the liquefied gas,
- the consequences of improper handling of equipment and the hazards that may result from a leakage of either liquid or gaseous ammonia,
- the action to be taken in the event of a spillage of ammonia,
- the recognition of defects on a RTC,
- the correct labelling of a RTC transporting liquid ammonia,
- the correct use of protective equipment, fire extinguishers and breathing equipment.

All operators should be regularly involved in practice drills for emergency response.

The qualifications and the training programme for operators who perform the loading/unloading activities should be recorded and such records kept. The results of the training programme should be evaluated regularly by both the employer and employees and corrective action should be taken when needed.

7.2.2 Operating instructions

The use of the job safety analysis method is recommended.

Written operating instructions for loading/unloading of RTCs should be available and directly accessible to the operators.

These instructions must cover all tasks that need to be performed during the loading/unloading operation. Special attention must be given to the health and safety and environment aspects.

The instructions should include the procedure for raising the alarm in case of an emergency and the tasks of the operators in the emergency response and evacuation situations.

Operating instructions should be handled as controlled documents. A system should be in place to guarantee that operators use the latest version.

The management should regularly monitor operations to ensure themselves that safe working practices are always adhered to.

A management of change procedure should be used to modify operating instructions.

7.2.3 Operator safety

Loading can be done by a single operator, who is permanently in the area of the loading station during the loading/unloading operation. However, loading and unloading operations should also be monitored by a second operator. This may be achieved by a second operator in the vicinity of the loading station or by a video camera link to a nearby location such as a plant control room.

Appropriate protective equipment shall be worn for the specific job to be carried out (See also chapter 6)

7.3 Loading operation

7.3.1 Checklists

Checklists should be used to ensure that all safety and quality checks are performed in a standardised and reliable way. On every RTC a number of checks must be carried out and measures taken BEFORE, DURING and AFTER its loading. The operator should check, register and sign the results. In this way, a history on the specific RTC is kept and safe loading operation conditions are created. Typical general checklist questions are summarised in Sections 7.3.5, 7.3.6 and 7.3.7. Additional plant specific checks may be added.

7.3.2 Suitability of the RTC

The general physical condition of the RTC should be checked by a RTC inspector on arrival in the plant facility. This check should include the condition of the brakes, wheels, tank, tank support structure, fittings, stairways and handrails.

A thorough identification check must be done before loading at the ammonia loading station:

- Verify the RTC number against the number mentioned in the loading documentation. Do not load if the numbers do not match.
- Check to ensure that the RTC has been approved for ammonia use.
- Check the design data as well as the inspection certificate for the date of the next tank inspection as well as the next RTC revision. If the inspection date has been passed,

the tank must not be filled and must be returned to a qualified workshop for the required inspection.

Pay special attention to the condition of flanges, couplings and gaskets during the preparations before loading. Missing or damaged items such as bolts, nuts, and gaskets must be replaced.

7.3.3 Purging

Purging with nitrogen may be needed prior to loading in some special cases. See 5.4

7.3.4 Filling weight and overfilling

The exact determination and control of the filling weight is of considerable importance. Overfilling an Ammonia RTC could result in one of the most dangerous loss of containment scenarios where the tank of the RTC can burst under the thermal expansion pressure of the liquid ammonia. This situation could occur when an RTC is overfilled to such an extent that there is too little gas space left, above the liquid, to accommodate the thermal expansion of the liquid ammonia. During the residence time of the ammonia in the RTC, the ammonia may become warmer due to ambient conditions, especially during extreme hot summer days. **For that reason the legally allowed maximum fill level of the RTC is limited to 0.53 kg ammonia/litre of effective tank volume.** If a RTC contains more than this legally allowed quantity it must be regarded as overfilled and immediate action should be taken to correct the situation. It should be stressed that overfilling is **not** defined as the level where liquid ammonia leaves the tank car via the gas return lines/pipes. Overfilling already happens at levels far below the point that liquid returns via the gas return line.

Regulations for the transport of dangerous goods stipulate the maximum filling weight for liquids in rail tank wagons. This depends on:

- The allowed maximum filling weight (capacity) of the tank which is written on the side of the tank.
- Weight restrictions on the route over which the tank car is to be transported. The maximum predetermined loading limit of the railway route will be given by the railway transport company. If the maximum filling weight of the railway route is less than the safe maximum filling weight of the railway tank wagon, the limit of loading weight is the lower value.

To prevent overfilling the filling weight has to be controlled by at least two independent measuring systems. The filling weight can be determined using the available systems listed below.

- The filling weight of the railway tank wagon is continuously monitored during the filling process on a weigh-bridge. The filling automatically ends when the predetermined maximum is reached.
- The mass flow into the tank is monitored continuously during the filling operation. The filling automatically ends when the predetermined maximum is reached.

- The weight of the RTC is additionally checked off line before transporting on an independent and officially calibrated scale or weigh-bridge. **Special care shall be taken to weigh the loaded RTC within 24 hours of filling.**

In this way the predetermined maximum weight is not exceeded and the availability of a vapour space on top of the liquid is guaranteed at all times. As already mentioned, legislation limits the amount of ammonia that is allowed to be filled in a RTC to 0.53 kg/l.

Additional indicative systems could be:

- Visual assessment of the tank level via infrared measurement,
- Ultrasonic measurement of the liquid level,
- A (visual) level gauge next to the loading pipe,
- A radioactive level gauge.

The following paragraph discusses the filling steps and outlines some unexpected potential sources for overfilling.

One important step in the filling process is to determine whether or not an empty RTC car is really empty. This is normally done on a weigh-bridge and communication between the weigh-bridge and the filling station is essential to avoid dangerous overfilling. Also, the weighing procedure applied, stand-alone on the bridge, coupled in a train, even moving, can be a source of weighing errors which can lead to overfilling. If the filling station is equipped with a weigh-bridge itself, the weighing procedure should be examined for sources of inaccuracy.

The input of the correct data for filling is mostly done manually and therefore can form a potential high-risk step.

When filling is monitored by measuring the volumetric/mass flow into the tank, all steps in determining and controlling the correct batch amount put into the monitoring equipment should be assessed for sources of error and preferably double-checked.

Finally, when an offline check of the RTC weight is performed on a weigh-bridge, this weigh-bridge is most likely the same one as that used for weighing the incoming empty RTC. Here again, the weighing procedure applied plays a role in the risk of not discovering over-weight RTCs. Also, a systematic error in the weigh-bridge could remain undiscovered since it is influencing the empty and filled weighing in the same way.

In assessing the risk of dangerous overfilling, the whole process of filling should be examined, including all steps, procedures and communication links to one another. Preferably a fault tree assessment, or equivalent (semi-) quantitative method for each different filling station is applied.

7.3.5 Checks and Actions Before Loading

- Check if the track access is closed (red light, derailment device).
- Check if the RTC is placed at the right loading station.

- Check the RTC identification number with the loading documents.
- Check the hazard labels and identification numbers (*see Figure 11*).
- Check to ensure the RTC is approved for ammonia.
- Check that the inspection date is not exceeded (*see Figure 15*).
- Properly secure the RTC (e.g. using wheel clamps).
- Check the Tare weight of the RTC (*see K in Figure 11*) versus the empty weight to establish the potential rest load in the RTC.
- Determine the exact loading quantity using the empty weight result, the tare weight, the route of the RTC (A, B, C, D Class) and the maximum fill level (0.53 kg/l tank volume).
- Check that the liquid and gas bottom valves and the liquid and gas site valves are fully closed.
- Remove the blinds from the vapour and liquid lines.
- Check the cleanliness of the RTC pipes and the tightness of the bottom and side valves.
- Make connection with loading arm.
- Remove the fixation pen/tie-*rap of the hand valve*.
- Connect the automatic shutdown cable and open the inner and the outer bottom valves in that order.
- Check the partial pressure of inert gases (see RID 4.3.3.4.3.b).
- Check and eventually remove previous hazard labels and identification numbers.
- Put in place the applicable hazard labels and identification numbers.

7.3.6 Checks and Actions During Loading

- Check the tightness of the fittings.
- Monitor the loading and check for leaks.
- Check that the predetermined loading quantity remains below the loading limit.

7.3.7 Checks and Actions After Loading

- Completely empty the connection lines of the RTC and loading/unloading arm.
- Check the bottom valves for total absence of leakages.
- Fully close all valves.
- Remove the loading arms.
- Apply the fixation pen/tie-*rap of the hand valve*.
- Install protective caps or blind flanges.
- Label the filling/discharge openings.

- Remove the automatic shutdown connection from the bottom valve.
- Check if the filling weight is in accordance with the loading documents (A, B, C, or D Class) and less than the maximum fill level.
- Check for product leakages.
- Double check that all the required hazard labels and identification numbers are in place.
- Ensure all loading documents including the RTC loading weight are available.
- Remove the securing and derailment device.

7.4 Unloading Operation

7.4.1 Checks and Actions Before Unloading

- Check if the track access is closed (red light, derailment device).
- Check the RTC identification number with the unloading documents and hazard labels (*see Figure 11*).
- Properly secure the RTC (e.g. using wheel clamps).
- Check whether the weight of the RTC is in accordance with the delivery documents.
- Check whether it is possible to unload the RTC fully into the storage tank.
- Check that the liquid and gas bottom valves and the liquid and gas site valves are fully closed.
- Check the bottom valve for total absence of leakage.
- Remove the blinds from the vapour and liquid lines.
- Check the cleanliness of the RTC pipes and that the bottom and site valves are tight.
- Make the connection with the unloading arm.
- Remove the fixation pen/tie-*rap of the hand valve*.
- Connect the automatic shutdown cable for automatic shutdown activation and open the inner and outer bottom valves in that order.
- Check the partial pressure of the inert gasses or the gauge pressure relative to the temperature of the liquid phase.

7.4.2 Checks and Actions During Unloading

- Check the tightness of the fittings.
- Monitor the unloading and check for leaks.

7.4.3 Checks and Actions After Unloading

- Completely empty the connection lines of the RTC and the loading/unloading arm.
- Check the bottom valves for total absence of leakages.

- Fully close all valves.
- Remove the loading arms
- Apply the fixation pen/tie-*rap of the hand valve*.
- Install protective caps or blind flanges.
- Label the filling/discharge openings.
- Remove the automatic shutdown connection from the bottom valve.
- Check for product leakages.
- Double check that all the required hazard labels and identification numbers are in place.
- Ensure that all documents are available.
- Remove the securing and derailment device.

8. TRANSPORTATION

8.1 Safety Responsibilities

EC Directive (96/35/EC; Ref. 6) requires any company or undertaking involved in the transport, loading or unloading of dangerous goods to appoint a Dangerous Goods Safety Adviser. This Directive covers road, rail and inland waterways. The minimum examination requirements are laid down in the Directive 2000/18/EC [Ref. 7].

The participants in the carriage of dangerous goods shall take appropriate measures to avoid damage or injury and, if necessary, to minimise their effects. They shall, in all events, comply with the requirements of RID in their respective fields.

The participants shall immediately notify the emergency services in case of immediate risk to the public and shall make available to them the information they require to take action.

RID may specify certain of the obligations falling to the various participants. If a Member State considers that no lessening of safety is involved, it may, in its domestic legislation, transfer the obligations falling to a specific participant to one or several other participants, provided that the obligations of RID 1.4.2 and 1.4.3 are met. These derogations shall be communicated by the Central Office (of the RID) which will bring them to the attention of the other Member States

The obligations of the participants shall not affect the provisions of domestic law concerning the legal consequences (criminal nature, liability, etc.) arising from the fact that the participant in question is for example, a legal entity, a self-employed worker, an employer or an employee.

It is mentioned in RID 1.8.5.1 that if a serious accident or incident takes place during loading, filling, carriage or unloading, the loader, filler, carrier, consignee or the railway infrastructure manager, respectively shall ascertain that a report is made for the authorities.

8.2 Obligations of the main participants

8.2.1 Consignor

The consignor (usually the seller of the ammonia) of dangerous goods shall only hand over consignments which conform to the requirements of RID. In this context he shall:

- (a) ascertain that the dangerous goods are classified and authorised for carriage in accordance with RID,
- (b) furnish the carrier with information and data and, if necessary, the required transport documents and accompanying documents. Part of this documentation is the MSDS for anhydrous ammonia [Ref. 9],
- (c) use RTCs approved for and suited to the carriage of ammonia and bearing the markings prescribed by RID,
- (d) comply with the requirements on the means of dispatch and on restrictions on forwarding,
- (e) ensure that even empty uncleaned tanks are appropriately marked, labelled, closed and present the same degree of leakproofness as if they were full.

If the consignor uses the services of other participants (e.g filler), he shall take the appropriate measures to ensure that the consignment meets the requirements of RID.

8.2.2 Carrier

The carrier (usually the local rail transport company) who takes RTCs filled with ammonia at the point of departure shall:

- (a) ascertain that the prescribed documentation is attached to the consignment note and is also forwarded,
- (b) ascertain visually that the RTCs and loads have no obvious defects, leakages or cracks, missing equipment, etc.,
- (c) ascertain that the date of the next test for the RTCs has not expired,
- (d) verify that the RTCs are not overloaded,
- (e) ascertain that the placards and markings prescribed for the RTCs have been affixed.

The carrier may, however, in the cases of (a), (d) and (e), rely on information and data made available to him by other participants.

If the carrier observes an infringement of the requirements of RID, he shall not forward the consignment until the requirements have been met.

The carrier shall ensure that the manager of the railway infrastructure being used is able to obtain, at any time during carriage, rapid and unrestricted access to the information allowing him to meet the requirements of the railway infrastructure manager (see below). The arrangements by which the data are provided shall be laid down in the rules for using the railway infrastructure.

If, during the journey, an infringement which could jeopardise the safety of the operation is observed, the loaded RTC shall be halted as soon as possible bearing in mind the requirements of traffic and public safety and of the safe immobilisation of the loaded RTC.

The transport operation may only be continued once the loaded RTC complies with the applicable regulations. The competent authority(ies) concerned by the rest of the journey may grant an authorisation to continue the transport operation.

If the required compliance cannot be achieved and no authorisation is granted for the rest of the journey, the competent authority(ies) shall provide the carrier with the necessary administrative assistance.

8.2.3 Consignee

The consignee (usually the buyer of the ammonia) is obliged not to defer acceptance of the goods without compelling reasons and to verify, after unloading, that the requirements of RID concerning him have been complied with.

He shall in particular:

- carry out the prescribed cleaning and decontamination of the RTCs in the cases provided for by RID,
- ensure that the RTCs once completely unloaded, cleaned and decontaminated, no longer bear placards and orange plates. A RTC may only be returned or reused once the above requirements have been met,
- If the consignee makes use of the services of other participants (unloader, cleaner, decontamination facility, etc.) he shall take the appropriate measures to ensure that the requirements of RID have been complied with.

8.3 Obligations of the other participants

A non-exhaustive list of the other participants and their respective obligations is given below. The obligations of the other participants arise from the general safety measures above insofar as they know or should have known that their duties are performed as part of a transport operation subject to RID.

8.3.1 Filler

The filler (usually the seller of the ammonia, who takes care of the filling) has the following obligations:

- to ascertain, prior to the filling of the tanks, that both they and their equipment are technically in a satisfactory condition,
- to ascertain that the date of the next test of the RTCs has not expired,
- to fill the tanks only with the dangerous goods authorised for carriage in those tanks,

- to observe, during the filling of the RTC, the maximum permissible degree of filling or the maximum permissible mass of contents per litre of capacity for the substance being filled,
- to check, after filling the RTC, the leakproofness of the closing devices,
- to affix the prescribed orange plates, danger labels or placards on the RTCs filled by him, in accordance with the requirements,
- to observe the applicable special checking requirements (RID 4.3.3.4; *see Annex 7*), before and after filling RTCs with a liquid gas.

8.3.2 Operator

The RTC operator (usually the RTC rental company) shall:

- ensure compliance with the requirements for construction, equipment tests and marking,
- ensure that the maintenance of the tanks and their equipment is carried out in such a way as to ensure that, under normal operating conditions, the RTC satisfies the requirements of RID until the next inspection,
- make a special check when the safety of the tank or its equipment is liable to be impaired by a repair, an alteration or an accident.

8.3.3 Railway infrastructure manager

The railway infrastructure manager shall:

- ensure that the internal emergency plans for marshalling yards are prepared in accordance with RID chapter 1.11
- ensure that he has rapid and unrestricted access to the following information at any time during carriage:
 - composition of the train
 - UN numbers of the dangerous goods being carried
 - position of the wagons in the train
 - weight of the load

This information shall only be disclosed to those parties that require it for safety, security or emergency response purposes.

8.4 Safety During Transport of Ammonia

8.4.1. General

All the parties involved should carry out a risk analysis on all the external ammonia transport from the supplier's site to the customer's site. Transport stops, shunting etc. must be carefully considered so that effective emergency action plans can be established.

Emergency action plans must contain all the steps to be taken should there be an accident or near-miss at any rail/shunting stations or during transit. This will ensure that all those involved work together in a co-ordinated way and that the risk for human injury/loss or environmental pollution is kept to a minimum (see Section 10).

The risk during shunting and locomotive interchange is generally significantly higher than in transit, but the consequences of an accident are usually minor and not dramatic.

The carrier should receive product information which will inform him of all the risks related to the product (ammonia).

The RTC must be marked according to current regulations. The marking must remain on the RTCs at all times, even if they are empty and the wagons must also be tightly sealed.

If anything occurs during transportation which affects the safety of the transport, the transportation must be terminated immediately so that routine checks can be carried out.

8.4.2 Safe transport of ammonia by RTCs

The consignor should report all departing RTCs to the carrier and consignee immediately.

The carrier should request notification of the arrival of the tank wagon at the customer's premises and inform the consignor immediately.

If the scheduled transit period has been exceeded, the carrier should immediately request information from the railway traffic department and discover the whereabouts of the RTC.

The responsible railway department, consignor and consignee should choose a safe route for the ammonia transport, based on risk analyses for different routes, to avoid urban areas and big towns if it is possible.

The responsible railway department, consignor and consignee should inform the local authorities about the ammonia transport routes and the amount of ammonia and the local authorities together with the carrier, consignor and consignee should draw up emergency plans for any accident with ammonia rail cars.

9. AUDITS

9.1 Safety and Quality Assessment Scheme

A Safety and Quality Assessment Scheme (SQAS) has been developed by European chemical companies with the aim of improving safety during the transport, storage and handling of chemicals.

SQAS provides a tool for independent assessors to assess the quality, safety and environmental management systems of logistics service providers in a uniform manner using a standard questionnaire. A SQAS assessment offers a detailed factual report which each chemical company needs to evaluate according to its own requirements and provides a mechanism for evaluating continuous improvement.

A SQAS package for rail carriers was launched in 2000 as a joint approach between European chemical companies and the UIC (Union Internationale de Chemins de Fer/ International Union of Railways).

The SQAS rail package consists of two documents which must be used together. These are:

- The SQAS Rail Guidelines;
- The SQAS Rail Questionnaire.

Both documents are available in three languages: English, French and German.

The SQAS questionnaire covers areas such as: management policy, training, recruitment, safety, health and environmental procedures, safety equipment, emergency response, customer focus, equipment maintenance and inspection, operational instructions, communications, security and site inspection.

EFMA recommends that only SQAS assessed carriers are used and that an action plan for further improvement is developed based on that assessment.

9.2 Internal Audits

Internal audits are used to determine the extent to which the company quality management system requirements, consisting of legal regulations and internal guidelines and regulations, are fulfilled. Audit findings are used to assess the effectiveness and to identify opportunities for improvement. EFMA has developed a Product Stewardship programme and compliance system for its members. This compliance system consists of an audit by an independent third party using a specially developed audit questionnaire. Part of this audit questionnaire covers transport by rail.

Internal audits should be conducted at planned intervals based on International Standards such as ISO 9001 and ISO 14001, and on EFMA's checklist. The audit programme shall be planned, taking into consideration all the relevant parts of ammonia loading and transportation. The audit criteria, scope, frequency and methods have to be defined. The selection of auditors and the conduct of audits must ensure objectivity and impartiality. Therefore auditors can not audit their own work

A written report should be prepared summarising the findings and necessary consequences of the internal audit.

The management responsible for the area has to ensure that actions are taken without delay to eliminate the detected nonconformities and their causes.

10. EMERGENCY RESPONSE

10.1 Behaviour of Ammonia on Loss of Containment

Ammonia gas or vapour, at ambient temperature as well as at -33°C (normal boiling point) is lighter than the ambient air, consequently, any release of vapour alone from a leaking flange of a RTC forms a buoyant plume, dispersing upwards in the atmosphere.

As a result of a severe collision it is possible that the pressurised tank of the RTC is damaged to such an extent that ammonia is released from it.

When liquid ammonia is suddenly released from a pressurised liquefied source part of the ammonia is vaporised. The escaping plume tends to be made up of flashed off ammonia vapour, entrained droplets of liquid ammonia and entrained ambient air. The degree of vapour flash is dependent on the temperature and pressure of the liquid ammonia. Pools of cold (-33°C) liquid ammonia on the ground can be formed either as a result of rainout from the release or from spills from the tank.

After an initial flash caused by the decrease in pressure and the input of conductive heat from the ground, the pool gradually cools down by convective vaporisation and the adiabatic saturation of air. The resulting cold mixture of air and ammonia will, in most cases, be heavier than the ambient air. The chilling effect produced either due to flashing or adiabatic saturation can cause visibility difficulties within the plume. In particular, a white dense fog will be formed near the source of the release.

As soon as an ammonia release has been detected measures must be taken to stop the release, if safe to do so and to control the consequences.

10.2 Protection of the Surrounding Communities

The population needs to be warned immediately when an ammonia incident occurs in an inhabited area and they may be affected by the escaping ammonia.

When an ammonia escape is potentially threatening, consideration may have to be given to the evacuation of the population living downwind of the incident. However evacuation is often potentially unsafe or impossible, as it takes time.

The population living in the danger zone need to be warned as soon as possible and advised to stay inside, close all doors, windows and ventilation openings and to use wet towels to cover openings under doors and windows. However, in the event of a prolonged release it may become necessary to evacuate.

10.3 Limiting the Release

Attempt to reduce the rate of escape of ammonia from a leaking RTC as soon as possible.

When liquid ammonia escapes from the RTC, the pressure in the reservoir will stay about constant until the liquid level in the RTC has dropped to the level of the escape point. When the escape is from the gas phase of a pressurised RTC, the evaporation of the liquid ammonia will decrease the temperature and the pressure in the RTC. After some time the reservoir will cool to -33°C (cold boiling) as the pressure reduces to atmospheric pressure. The amount of ammonia that is released from that moment onwards is dependent on the amount of external heat that is transferred to the RTC.

The leaking RTC should not be sprayed with water because the water that is normally available to control ammonia gas clouds is warmer than the tanker containing the cold boiling ammonia.

The release can be limited by:

- Closing the leak opening with provisional measures,
- Repairing the leaking valve/flange connection,
- Transferring the ammonia to another RTC.

10.4 Limiting the Vaporisation

Vaporisation of the released ammonia can be controlled by:

- Limiting the size of the liquid ammonia pool. An earth dike or sandbags can be very effective for limiting the pool size and will limit the heat input from the ground,
- Covering the liquid ammonia pool with a layer of fire-fighting foam. The foam layer will limit the heat input from the air,
- Breaking the jet of a spray release. If an obstacle e.g. a screen is placed in the path of a spray or jet, some of the liquid droplets present in it will separate out forming a pool on the ground.

10.5 Dissolving Ammonia in Water

Ammonia dissolves very easily in water but large quantities of water are needed to be effective.

Never spray water directly into a pool of liquid ammonia unless a hundredfold excess of water is immediately available.

10.6 Lowering the Concentration of Ammonia Gas/Vapour in Air

When a cold ammonia cloud mixes with air it forms a white fog in the form of an aerosol which is heavier than air. The gas cloud travels close to the ground.

The gas cloud and the aerosol can be fought effectively with water screens or water curtains set up in the path of a travelling plume. The water screens should be placed between the release point and the threatened area. Multiple water screens may be necessary to obtain a good coverage of the plume by the water curtains and to supply as much water as possible.

10.7 Fire Fighting Measures

Ammonia vapour and liquid spills are difficult to ignite, particularly in the open air.

In an enclosed space, mixtures of ammonia and air within the limits (16-27%), may explode when ignited. A cold, dense cloud of ammonia may impair visibility.

The following actions are recommended in the event of an indoor release.

- Attempt to isolate the source of the leak,
- Use foam, dry powder or CO₂,

- Use water sprays to cool fire-exposed containers and structures, to disperse vapours and to protect personnel. Do not spray water into liquid ammonia,
- Wear self-contained breathing apparatus and full protective clothing.

10.8 Emergency Measures

The following is a resume of the emergency response measures:

- Approach the place of the accident from upwind.
- Wear full protective clothing including respiratory protection when dealing with a major release.
- Warn people immediately if the escaping ammonia can affect them.
- Evacuate the area down-wind of the release only if it is safe to do so and the release is life-threatening.
- Isolate the source of the leak as quickly as possible using trained personnel, if safe to do so.
- Contain the spillage if possible.
- Remove any ignition sources.
- Consider covering the liquid pool with foam to reduce evaporation.
- Use water sprays to combat gas clouds. Do not apply water directly into large ammonia spills.
- Use water sprays to cool fire-exposed containers in case of fire.
- Take care to avoid the contamination of watercourses.
- Inform the appropriate authorities in case of accidental contamination of watercourses or drains.

10.9 Additional Information on Emergency Response

10.9.1 Emergency Plan at Loading/Unloading Sites

Sites where large quantities (> 50 tonnes) of ammonia are present are subject to the Seveso Directive [Ref. 8]. Article 9 of this Directive requires the operator* to prepare on-site and off-site emergency plans and to produce a safety report. This report is required to provide information to enable the external plan to be drawn up in order to take the necessary measures in the event of a major accident.

The emergency plans must be communicated to the public and the services or authorities concerned in the area. The plans have to be reviewed, tested and when necessary, revised and updated by the operators and designated authorities at suitable intervals.

* "Operator" in the context of Seveso, means any individual or corporate body who operates or holds an establishment or installation or, if provided for by national legislation, has been given decisive economic power in the technical operation thereof.

10.9.2 System of Reciprocal Assistance in Transport Emergencies

International Chemical Environment (ICE) is a co-operative programme, set up by European chemical companies with the aim of improving safety during the transport, storage and handling of chemicals. An important part of the system is the ability to respond to transport incidents involving chemicals.

In the event of an incident, the chemical industry will provide information, practical help and, if necessary and possible, appropriate equipment to the competent emergency authorities in order to bring the incident under control and to minimise any adverse effects.

Within this system the chemical industry offers three levels of assistance:

Level 1: Remote product information and general advice by telephone or fax.

Level 2: Advice from an expert at the scene of an incident.

Level 3: Assistance with personnel/equipment at the scene of an incident.

When a transport incident occurs, the Fire Service normally tries to contact the supplier of the goods if assistance is required. If this fails, ICE offers the authorities the possibility of contacting other companies which have committed themselves to provide assistance for a range of products. In every country of the ICE system, a national centre may facilitate mutual assistance between companies, especially when incidents occur during international movements. Those national centres will look for assistance across country boundaries, using English as the common language between national centres.

The focal point of a national ICE scheme is the national ICE centre which the emergency authorities may call:

- when the supplier cannot be contacted;
- when an incident happens to international movements necessitating contact with national ICE centres in other countries;
- when mutual assistance needs to be mobilised within the national ICE scheme;
- when the product or the producing company cannot be readily identified.

When called by the authorities, the national ICE centre will provide, in the local language, initial telephone advice for the immediate control of the incident. It will promptly alert the producing company, obtain further information (possibly via other national ICE centres) or mobilise mutual assistance. To do this, the centre has at its disposal appropriate communication equipment, a library of reference books or databases and up to date lists of telephone and fax numbers for contacts within the chemical industry.

There are seventeen national schemes already existing in Europe. Other countries are being progressively added and the ultimate aim is to cover the whole of Europe.

Examples of existing national schemes are those in Germany and Austria (TUIS: Transport – Unfall – Informations- und Hilfeleistungssystem, founded in 1982 and 1984 respectively), in France (TRANSAID, founded in 1989) and in the UK (CHEMSAFE).

10.10 Incident Information Sharing

10.10.1 Rapid Alert System

In 2002 EFMA set up a Rapid Alert System (RAS) for the quick reporting of accidents. Any accident or incident, which has been reported in the media and/or could have a major impact on the fertilizer industry (e.g. fatalities, environmental release, potential disaster, terrorist threat) related to the production, storage or transport of fertilizers or their raw materials such as ammonia, nitric acid etc. is immediately reported to EFMA.

In turn EFMA informs each of the member companies.

10.10.2. Accident fact sheets

EFMA member companies report any relevant accident or incident to EFMA in more detail using an Accident Fact Sheet designed for this purpose. This Accident Fact Sheet contains the relevant information of such an accident/incident, analyses of the cause(s) and recommendations. It enables EFMA's experts to give recommendations and guidance to prevent such accidents/incidents happening again.

11. QUESTIONS AND ANSWERS REGARDING THE RAIL TRANSPORT OF AMMONIA

Why is the rail transport of ammonia required?

Ammonia is used as a base chemical for a large number of intermediate products that find their use in many applications. As a result of international competition ammonia can only be produced economically in large scale production plants. If a production site has an ammonia consumption that is a lot smaller than the economical size of an ammonia plant, it is required to transport ammonia to this site. Rail transport is regarded as a safe means of transport for large quantities of ammonia.

What are the alternatives to rail transport?

The alternative forms of transport include pipeline, large sea-going vessels, river barges, rail tank cars and tank trucks (except in Germany). Inside Europe ammonia is transported by river barges, rail tank cars and tank trucks. In Europe there are no long-distance pipeline systems. The most comparable transport form for large quantities versus rail tank cars is river barges. The locations that need to import ammonia are not necessarily located next to a canal suitable for river boats. The advantage of rail tank cars is that they can reach more locations and the transferred load is around 50 tes per rail tank cars versus around 1000 tes for river boats.

What special regulations are available for the transport of ammonia in rail cars?

The transport of ammonia is controlled by national and international regulations for the transport of dangerous goods (Regulations concerning the International carriage of Dangerous goods by Rail). In these regulations specific items are described regarding the rail tank car, the load, dangerous goods identification and warning plates, the training of the personnel, etc. There are no specific requirements for ammonia that go beyond the regulations for the transport of other liquefied pressurised gasses and toxic materials.

What is the danger of leakage during a derailment of an ammonia rail tank car?

The danger of an ammonia leakage during a derailment is very small. The tank itself is of a very rigid construction. The rail tank cars for the transport of ammonia are designed and constructed for an internal pressure of 26 bar (2,6 Mpa), whereas the normal operating pressure is 5-12 bar. It is extremely rare for a rail tank car to rupture after a derailment or collision. Regulations require that the tanks are equipped with internal shut-off devices. If the loading/unloading pipelines on the tank are damaged due to a derailment or collision these internal valves can prevent the release of ammonia.

How can you recognise a rail tank car used for the transport of ammonia?

Rail tank cars suitable for the transport of liquefied gasses such as ammonia, have a horizontal orange stripe 30 cm wide in the middle of and along the whole tank. The rail tank cars have one orange plate with black marking on each side. The material identification number UN 1005 indicates that the content of the tank is ammonia.

What safety precautions are taken for safe loading/unloading of ammonia?

Loading/unloading stations are designed according to national and international adopted design standards. During the design, standardised safety studies are carried out to identify the possible dangers during loading and unloading. Measures are taken to reduce the possible dangers to acceptable levels when required.

Loading and unloading is undertaken by qualified personnel in accordance with prescribed instructions and procedures.

What are the properties of ammonia?

Ammonia is a colourless, and poisonous gas with a very pungent odour. Under pressure the gas can be liquefied. Ammonia gas is lighter than air. It is a strong base and can react vigorously with acids. Ammonia is very soluble in water and heat is released in the process.

Are rail tank cars filled with ammonia a fire hazard?

Ammonia does not burn easily. A pool of liquid ammonia does not burn in a self-sustainable way. The fire hazard is therefore minimal compared to hydrocarbons. Should ammonia start burning the fire does not present a serious thermal hazard due to its low heat radiation to the surroundings.

What do I do if I smell ammonia?

Ammonia can be smelled at very low concentrations. Some people can smell ammonia even at a concentration of 5 ppm. Most people smell ammonia at concentrations between 20 and 50 ppm which are far below the life threatening concentration levels. When inside buildings, close all windows and doors and shut off all ventilation systems such as air conditioning. When outdoors, walk across the wind direction away from the threatened area.

Is an ammonia cloud visible?

An ammonia cloud is visible as a white dense fog.

How is an ammonia release contained?

The most important measure is to stop the release to limit the amount released, for example by closing the appropriate valves. Ammonia clouds can be effectively suppressed by using water screens. The water readily dissolves ammonia.

Is it possible for an ammonia rail tank car to explode?

Technically it is possible that the tank of a rail car can burst due to excessive pressure and this can be referred to as a physical explosion. This could happen when the rail tank car is overfilled and exposed to excessive heat or fire. A detonation can be ruled out.

What happens when liquid ammonia is spilled from a rail tank car?

A small leakage of liquid ammonia will evaporate immediately and the resulting gas cloud is likely to cause annoyance. A larger leakage can form a cloud of ammonia and a pool of liquid ammonia. The liquid ammonia will evaporate. The evaporation rate depends on the heat input from the surroundings. The large vapour cloud can be hazardous. The cloud will spread and will slowly be diluted depending on the weather conditions. A large area downwind can be affected.

12. REFERENCES

- 1) Recommendation on the Transport of Dangerous Goods: Model regulations. 13th revised edition, 2003. United Nations Publication ISBN 92-1-139090-7.
- 2) Convention concerning International Carriage by Rail (COTIF). Appendix B. Uniform Rules concerning the Contract for International Carriage of Goods by Rail (CIM). Annex I Regulations concerning the International Carriage of Dangerous Goods by Rail (RID). 2005 Edition. ISBN 84-498-0742-5.
- 3) Directive 2000/62/CE of the European Parliament and of the Council of 1 October 2000 amending Directive 96/49/EC on the approximation of the laws of the Member States with regard to the transport of dangerous goods by rail. OJ No. L279, 1.11.2000, p.44.
- 4) Council Directive 2001/6/EC of 29 January 2001 adapting for the third time to technical progress Council Directive 96/49/EC on the approximation of the laws of the Member States with regard to the transport of dangerous goods by rail. OJ No. L30, 12.2001, p.42.
- 5) Ullmann's Encyclopedia of Industrial Chemistry, Release 2002, 6th edition.
- 6) Council Directive 96/35EC of 3 June 1996 on the appointment and vocational qualification of safety advisers for the transport of dangerous goods by road, rail and inland waterway. OJ No. L145, 19.6.1996, p.10.
- 7) Directive 2000/18/EC of the European Parliament and of the Council of 17 April on the minimum examination requirements for safety advisers for the transport of dangerous goods by road, rail and inland waterways. OJ No. L118, 19.5.2000, p.41.
- 8) Council Directive 96/82/EC of 9 December, 1996 on the control of Major Hazards involving Dangerous Substances. OJ L01/97 as amended by Directive 2003/105/EC. OJ No. L345/97, 11.12.2003.
- 9) EFMA 1996. Guidance for the compilation of safety data sheets for fertilizer materials.
- 10) Guidance for the large scale storage of fully refrigerated anhydrous ammonia in the UK. Chemical Industries Association second edition June 1997. ISBN 0 90062 359 4.
- 11) ATEX Guidelines (first edition). Guidelines on the application of Council Directive 94/9/EC of 23 March 1994 on the Approximation of the Laws of the Member States Concerning Equipment and Protective Systems Intended for Use in Potentially Explosive Atmospheres. May 2000.
- 12) EFMA's Product Stewardship Program. General brochure and CD ROM, 2003.
- 13) Hazardous Properties of Ammonia, EFMA/IFA publication, 1990.
- 14) K. D. Shah, Safety, Health and Environmental Aspects of Ammonia, 1997 – The Fertiliser Society, Proceedings 401, ISBN 0 85310 0357.
- 15) Liv Lunde and Rolf Nyborg: "The effect of Oxygen and Water on Stress Corrosion Cracking of Mild Steel in Liquid and Vaporous Ammonia", Ammonia Plant Safety, Vol. 27, American Institute of Chemical Engineers.

ANNEX 1: AMMONIA RAIL TRANSPORT ACCIDENT ANALYSES

EFMA has analysed the reports of European ammonia rail transport accidents from four databases, to estimate their extent. (See Table 1)

Table 1 EUROPEAN AMMONIA ACCIDENTS

Data Base	Selected ammonia accidents	Ammonia Rail accidents (World wide)	Years
TNO	487 ⁽¹⁾	77	1964-2002
AIChE	367 ⁽¹⁾	33	1934-2000
EFMA accident register	114 (all accidents)	5	1971-2003
EFMA Ammonia accident register	228 ⁽¹⁾	15	1969-2002

Note: ⁽¹⁾ survey contains ammonia accidents in production, loading and transport only.

From the above table it becomes clear that the majority of ammonia accidents worldwide are not related to rail transport. In particular, the food processing industry, where ammonia is used as a coolant, has frequently reported accidents.

38 unique European accidents were selected for further analysis.

1 Place of the accidents

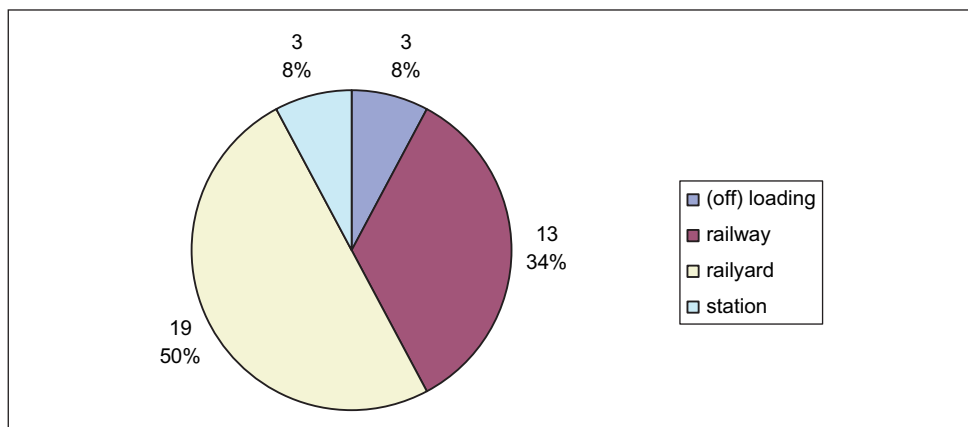

Diagram 1

Diagram 1 shows that 92% of the accidents happened during transport and 8% during loading/unloading.

2 Causes of the accidents

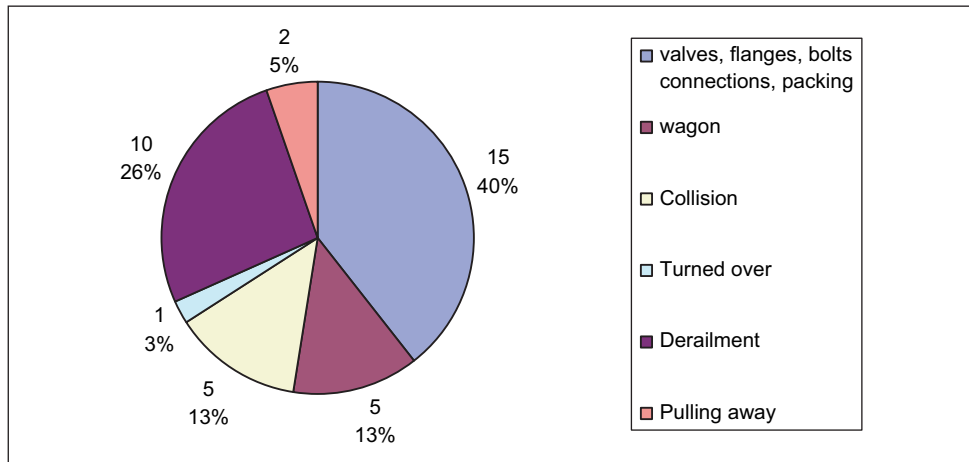

Diagram 2

In 55% of all cases train derailment, turn over or collision was the cause of the accident. In 5% of the cases the accidents were due to railcars pulling away whilst they still were in the loading/unloading area. In 40% of the cases the accidents were due to flanges, valves, packing, or bad connections. Sometimes in these cases there was some loss of containment or only a minor release.

3 Accidents selected according to loss of containment

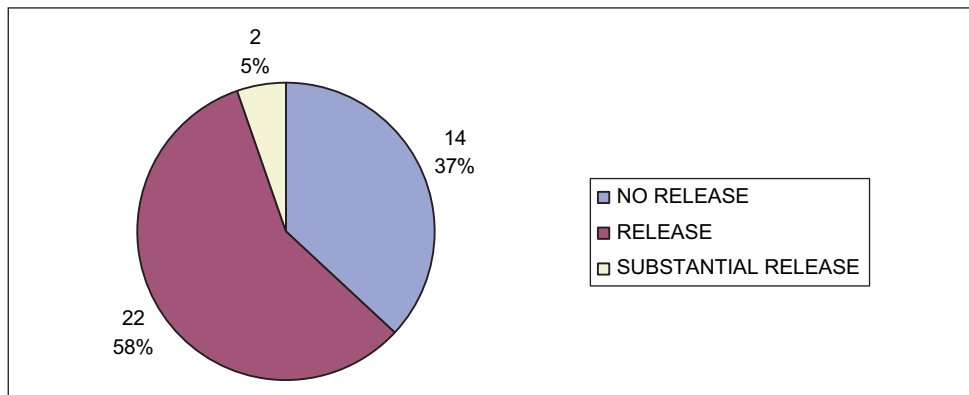

Diagram 3

In 95% of all cases there was no release or only a very minor release of ammonia. In the remaining 5% of the cases the loss of containment was somewhat more substantial.

4 Casualties/injuries due to loss of containment

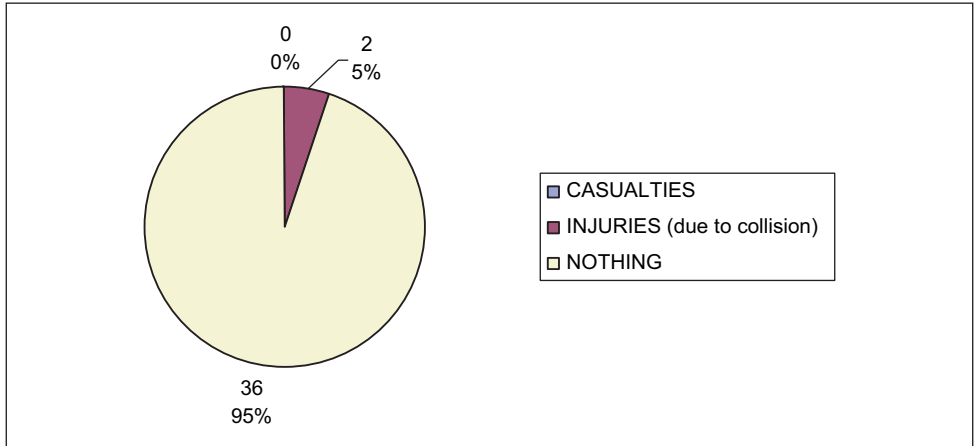

Diagram 4

It is important to note that in none of the cases were there any casualties due to loss of containment of ammonia.

Important learning points to note:

- Given that more than 1.5 million tonnes of ammonia (approximately 30,000 RTCs) are transported in Europe each year, only a few accidents have happened over the last 30 years.
- In none of the accidents were there any casualties or injuries due to the release of ammonia.
- The following points need more attention to increase safety and diminish the number of accidents:
 - Secure measures to prevent “pulling away” of rail tanks during loading/unloading
 - Secure measures to prevent leakage from valves, couplings etc. due to overfilling, loose fittings etc.

Accidents due to derailment, collision and turn over are out of the direct control of the ammonia producers but need more attention.

ANNEX 2: ABBREVIATIONS

ACME	Company name – ACME (Screw Couplings).
AIChE	American Institute of Chemical Engineers
ATEX	Atmosphères Explosibles (guidelines related to Directive 94/9/EC)
Bar	0.987 atm =100 kPa
CAS	Chemical Abstracts Service Registry Number
DIN	Deutsches Institut für Normung
EC	European Community
EFMA	European Fertilizer Manufacturers' Association
EU	European Union
IBC	Intermediate Bulk Container
ICE	International Chemical Environment
ISO	International Organization for Standardization
kg/m ³	Kilogram per cubic metre
kJ	Kilojoule = 0.239 kcal
kPa	Kilopascal
LC ₅₀	Lethal Concentration (median) for 50% of the population under test
MAC	Maximum Allowable Concentrations
MEGC	Multiple Element Gas Containers
MPa	Megapascal = 1,000 kPa
MSDS	Material Safety Data Sheet
NF	Norme Français
NH ₃	Ammonia
Ns/m ²	Newton-second per square metre
ppm	Parts per million
Q&A	Questions and Answers
RAS	Rapid Alert System
RID	Réglement International pour le transport de marchandises Dangereuses par chemin de fer.
RTC	Rail Tank Car
SCC	Stress Corrosion Cracking
SQAS	Safety and Quality Assessment Scheme
TLV	Threshold Limit Value
TNO	Netherlands Organisation for Applied Scientific Research
TUIS	Transport Unfall Informations und Hilfeleistungssystem
TWA	Time Weighted Average
UIC	Union Internationale de Chemins de Fer
UIP	International Union of Private Wagons
UN	United Nations
v/v	volume per volume
WECO	Trade mark (screw couplings)

ANNEX 3: NOMOGRAPH TO SHOW SOME PROPERTIES OF AMMONIA (Ref. 10)

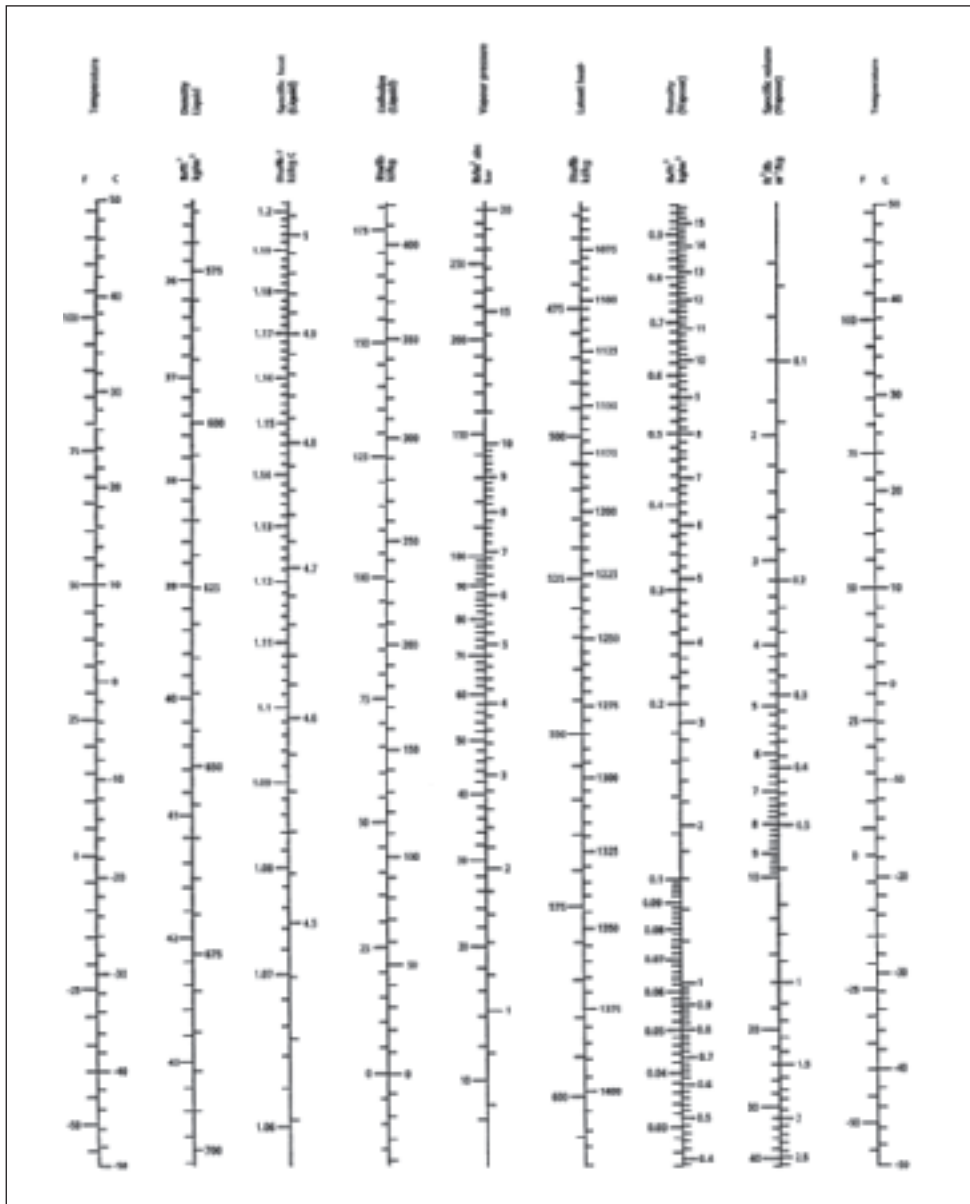

ANNEX 4: METHODS USED TO MITIGATE THE CONSEQUENCES OF A LOSS OF CONTAINMENT

Three methods are described for mitigating the consequences of a loss of containment of ammonia:

- The use of water curtains,
- Dynamic Semi Confinement,
- The system developed by Yara.

1 Water curtains

Water curtains are very effective in reducing the concentrations of ammonia downwind in the event of an accidental release. A water curtain system can be installed around the loading/unloading area. The main parts of a water curtain system are:

- a secure connection to a water supply system,
- a pump for the pressure of water,
- a piping system around the RTC loading area,
- emergency push buttons at strategic positions in the area to activate the system,
- an alert system in the control room,
- a waste water system.

If a release of ammonia is detected, the spray water to the hydro-shields or spray nozzles opens by pushing an emergency push button, or opens automatically when triggered by the rail-hook (*see Figures 23 and 24*).

2 Dynamic Semi-Confinement

This type of installation is an alternative, used for unloading facilities in small sites, when ammonia is stored at ambient temperature and in small quantities (less than 60 tes). The concept is derived from the standard design applied to the ammonia circuits in ammonia-based refrigeration units (norm NF EN 378).

The whole unloading facility (and eventually the storage vessel) is located in a building of standard construction specifications. The ventilation of the building is monitored using an extractor/ventilator (forced ventilation) with a variable speed, allowing flow rates from 9,000 m³/h up to 60,000 m³/h. The extracted air is discharged at some height (30 m) through a simple chimney.

When the doors are closed, the bottom part of the building is airtight, but openings with inner shutters are located in the walls 1 m above ground level, allowing the air to enter the building with a minimum loss of flow, even at maximum ventilation flow conditions.

The main door is closed after the tank which is to be unloaded has been parked inside the building. The operator in charge of connecting the tank to the unloading arm enters the building wearing protective clothes, gloves and a face mask with cartridge, which is worn



Figure 23 The water curtain system in action. The sprayed water builds a closed curtain



Figure 24 The ammonia loading area. The complete RTC is covered with water from the hydro-shields

during the whole time he is in the building. After coupling the tank to the unloading lines, he goes outside the building. The doors are closed and remain closed during the unloading operations. The forced ventilation system is started and set to run at minimum flow. The safety system, including ammonia sensors and the safety valves command system, is also activated. The unloading operations are remotely controlled by the operator from an operating panel located outside the building, and controlled by a video camera (with an extra screen in the main control room).

The area near the ammonia lines is equipped with back-up ammonia detectors (electrochemical cells for instance). If a significant amount (25 to 50 ppm) of ammonia is detected in the air, indicating a loss of containment of the circuits, the high flow ventilation is immediately activated, the unloading procedure is stopped and the alarm is raised.

Safety studies have shown that there will be no irreversible effect for any people at ground level from an accidental release of ammonia from the breakdown of the connection between the tank and the arm, provided safety devices that isolate the storage vessel and the tank activate within 30's (worst scenario). This is due to the dilution/dispersion effects of the ventilation and discharge conditions.

The electrical installation at the interior of the building must be of a "non-sparking" type, to prevent gas explosion risks. In addition, all the safety devices (detectors, ventilator, command system, etc.) have to be fed by an independent back-up supply.

3 Yara system

This system can be used to handle small leaks of liquid ammonia from a pipeline. In this context, re-liquefaction means that the small droplets of a spray release are converted into bigger droplets and finally into a liquid stream by the impact of the droplets on a solid surface.

Re-liquefaction using a hopper

The equipment used for re-liquefaction is in the form of a hopper fitted with securing attachments with the conical end of the hopper connected to a hose.

To stop the ammonia leakage, the opening of the hopper must be placed over the hole from where ammonia is escaping and the jet stream is fed into the hopper (*see Figure 25*).

The jet stream's forces are very powerful thus the hopper must be secured in the required position by means of attachments. This must be done in such a way that even the smallest amounts of air will be sucked into the hopper. This has the immediate effect of reducing gas liberation to the surrounding area.

Collection basins

The ammonia liquid must be collected in a provisional basin after re-liquefaction. This basin may be a hole in the ground lined on its sides and bottom with tarpaulin, preferably in the same material as the hopper.

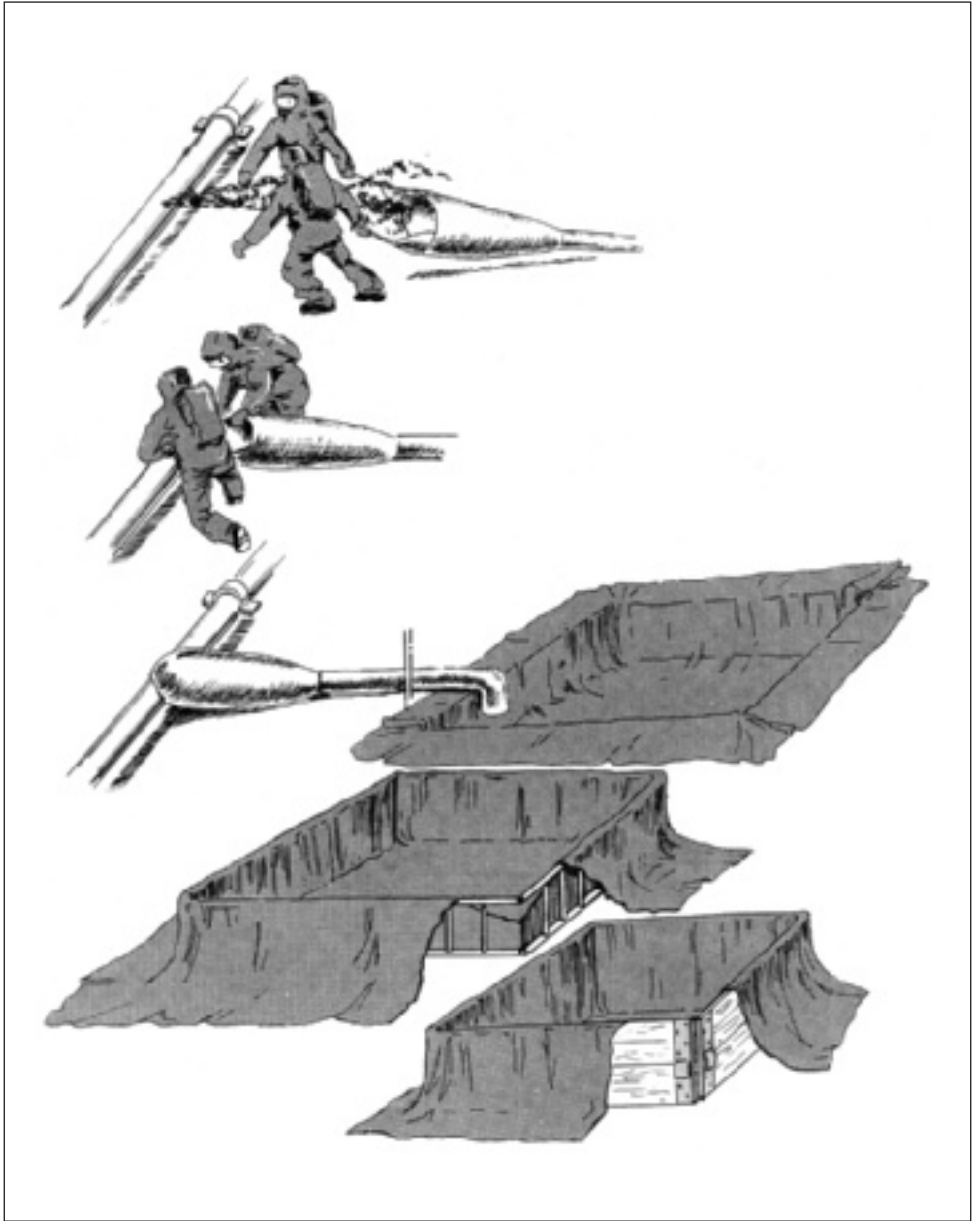

Figure 25 Re-liquefaction technique using a hopper and collection basin to control an ammonia leakage

As an alternative the basin could be made from pallets or extending ladders put together to form a square frame with sides and lined as above with tarpaulin. These constructions should not allow for self-draining as the condensed liquid needs to come up over the edge of the basin. This can be achieved by lifting up the hose and emptying its contents into the basin.

Evaporation can be reduced to a minimum by covering the basin with a tarpaulin.

Pumping

The liquid ammonia must be transferred to a more suitable storage tank after re-liquefaction. The best way to do this is by pumping. If there is no ammonia pump available, an electrically-operated submersible standard pump in stainless steel could be used for a short period.

If there is a degassed, unpressurised pressure tank available, which is suitable for ammonia, then the ammonia liquid may be pumped over to this tank. The tank must be left open to the air during filling, so that no overpressure is created inside the tank. When filled, the tank must be sealed.





If there is no suitable hose for liquid ammonia, a heliflex plastic hose may be used for a short time.

Protective Equipment

The emergency personnel who will be working in the immediate vicinity of a leak must be prepared for splashes from an extremely cold liquid or exposure to an extremely cold gas. Breathing apparatus, a full set of chemical protective clothing and external cold-proof protection against the low temperatures is essential.

It is not possible to make a general statement on the safety levels to be applied in these circumstances. An assessment has to be made as and when an incident occurs.

ANNEX 5: EXAMPLE OF A CHECKLIST

hazardous material commissioner version 1/ 2004		Checklist for pressure gas RTC Product Ammonia		
1	RTC-number:	Date:		
2	Last product:	Tester name:		
3	RTC lessor:			
4	Recipient:			
5	Hazard labels exist on both sides of the RTC? (Size 25 x 25 cm) (15 x 15 cm also possible)	Label from pattern 2.3		Yes / No
		Label from pattern 8		Yes / No
6	Shunt label exists on both sides? (Size 105 x 74 mm)	Label from pattern 13		Yes / No
Remove old hazard labels!				
7	Orange coloured warning plates exist on both sides?			Yes / No
8	Date of next tank revision:			
9	Date of next chassis revision:			
10	Is the loading good and is ammonia named on the tank plate?			Yes / No
11	Maximum permissible filling mass on tank plate (kg):	Loading quantity (kg)		
12	Do the labels "Ammonia" exist on the wagon panel on the both sides?			Yes / No
13	Is the RTC filled correctly (and in accordance with what is max. allowed)?			Yes / No
14	Are bottom valves and site valves checked for leakproofness?			Yes / No
15	Are all the fittings and devices properly sealed?			Yes / No
16	Are all protective caps or blind flanges in place and properly tightened? (all elements used)			Yes / No
17	Is the interlocking of the bottom valves (gas and liquid phase) checked?			Yes / No
18	Are all the fittings, flanges and the manhole tight?			Yes / No
19	Are all loading documents available?			Yes / No
20	Notes:			
21	RTC is ready for forwarding			The worker is responsible for the safekeeping of the checklists
	Date:	Time:	Signature:	

ANNEX 6: GLOSSARY OF TERMS USED

For the purpose of this document the following definitions apply

ADR

The European Agreement concerning the International Carriage of Dangerous Goods by Road, including all special agreements signed by those states involved in the transport operation.

Carriage

The change of place of dangerous goods, including any stops made necessary by transport conditions and including any period spent by the dangerous goods in wagons, tanks and containers due to traffic conditions before, during and after the change of place.

Note: This definition also covers the intermediate temporary storage of dangerous goods in order to change the mode or means of transport (transshipment). This shall apply provided that the transport documents showing the place of dispatch and the place of reception are presented on request and provided that packages and tanks are not opened during the intermediate storage, except to be checked by the competent authorities.

Carriage in bulk

The carriage of unpackaged solids or articles in wagons, tanks or containers.

The term does not apply to packaged goods nor to substances carried in tanks.

Carrier

The enterprise which carries out the transport operation with or without a transport contract.

Competent authority

The authority or authorities or any other body or bodies designated as such in each State and in each specific case in accordance with domestic law.

Consignee

The consignee according to the contract for carriage. If the consignee designates a third party in accordance with the requirements applicable to the contract for carriage, this person shall be deemed to be the consignee within the meaning of RID. If carriage takes place without a contract for carriage, the enterprise which takes charge of the dangerous goods on arrival shall be deemed to be the consignee.

Consignment

Any package or packages, or load of dangerous goods, presented by a consignor for carriage.

Consignor

The enterprise which dispatches the dangerous goods either on its own behalf or for a third party. If carriage takes place under a contract for carriage, consignor means the consignor according to the contract for carriage.

Dangerous goods

Those substances and articles the carriage of which is prohibited by RID, or authorised only under the conditions prescribed therein.

Enterprise

Any natural person, any legal person, whether profit-making or not, any association or group of persons without legal personality, whether profit-making or not, or any official body, whether it has legal personality itself or is dependent upon an authority that has such personality.

Filler

Any enterprise which loads dangerous goods into a tank (tank-vehicle, wagon with demountable tank, portable tank or tank-container) and/or into a wagon, large container or small container for carriage in bulk, or into a battery-wagon or MEGC.

Hermetically closed tank

A tank whose openings are hermetically closed and which is not equipped with safety valves, bursting discs or other similar safety devices. Tanks having safety valves preceded by a bursting disc shall be deemed to be hermetically closed.

IMDG Code

The International Maritime Dangerous Goods Code for the Carriage of Dangerous Goods, for the implementation of chapter VII, part A, of the International Convention for the Safety of Life at Sea, 1974 (SOLAS Convention), published by the International Maritime Organization (IMO), London.

Leakproofness test

A test for determining the leakproofness of a tank, packaging or IBC and of the equipment or closure devices.

Manual of Tests and Criteria

The fourth revised edition of the United Nations Recommendations on the Transport of Dangerous Goods, Manual of Tests and Criteria, published by the United Nations Organization.

Maximum permissible gross mass

The tare of a tank plus the heaviest load authorised for transport.

Mild steel

A steel having a minimum breaking strength between 360 N/mm² and 440 N/mm².

Operator (of a tank-container, portable tank or tank wagon)

The enterprise in whose name the tank-container, portable tank or tank wagon is registered or approved for transport.

Railway infrastructure

All the tracks and fixed equipment necessary for the movement of rail traffic and transport safety.

RTC

A Rail Tank Car equivalent to a Tank Car and or Tank Wagon.

Shell

The sheathing containing the substance (including the openings and their closures).

Structural equipment (for the tanks of a tank wagon)

The external or internal reinforcing, fastening, protective or stabilising members of the shell.

Tank

A shell, including its service and structural equipment.

Tank wagon

A wagon intended for the carriage of liquids, gases, powdery or granular substances, comprising a superstructure, consisting of one or more shells and an underframe fitted with its own items of equipment (running gear, suspension, buffing, traction, braking gear and inscriptions).

Tare

The weight of a rail wagon without the weight of the goods it contains.

UN Model Regulations

The Model Regulations annexed to the thirteenth revised edition of the Recommendations on the Transport of Dangerous Goods published by the United Nations.

UN number

The four-figure identification number of the substance or article taken from the UN Model Regulations.

Wagon

A rail vehicle without its own means of propulsion that runs on its own wheels on railway tracks and is used for the carriage of goods.

ANNEX 7: SPECIAL CHECKING REQUIREMENTS BEFORE AND AFTER FILLING OF CLASS 2 PRODUCTS (E.G. AMMONIA) REFERRED TO IN RID 4.3.3.4.

4.3.3.4 Provisions for the loading of liquid gas tank wagons

4.3.3.4.1 Control measures before loading

- (a) For each gas to be carried, the details on the tank plate (see 6.8.2.5.1 and 6.8.3.5.1 to 6.8.3.5.5) shall be checked to agree with those on the wagon panel (see 6.8.2.5.2, 6.8.3.5.6 and 6.8.3.5.7).

Tank wagons for multiple use shall especially be checked to ensure that the correct folding panels are visible on both sides of the wagon.

The load limits on the wagon panel shall not exceed the maximum permissible filling mass on the tank plate.

- (b) The last load shall be determined, either from particulars in the consignment note or by analysis. If necessary, the tank shall be cleaned.
- (c) The mass of the residue shall be determined (e.g. by weighing) and taken into account in determining the filling quantity.
- (d) The leakproofness of the shell and its items of equipment, and their ability to function, shall be checked.

4.3.3.4.2 Loading procedure

For loading, the provisions of the operating instructions of the tank wagon shall be complied with.

4.3.3.4.3 Control measures after loading

- (a) After filling, whether the wagon is overfilled or overloaded shall be checked by calibrated checking devices (e.g. by weighing on a calibrated weigh-bridge). Overfilled or overloaded tank wagons shall be immediately discharged in a safe manner until the permitted filling quantity is reached.
- (b) The partial pressure of inert gases in the gas phase shall not exceed 0.2 MPa (2 bar), or the gauge pressure in the gas phase shall not exceed by more than 0.1 MPa (1 bar) the vapour pressure (absolute) of the liquid gas at the temperature of the liquid phase.
- (c) After loading, bottom-discharge wagons shall be checked to ensure that the internal shut-off devices are adequately closed.
- (d) Before blank flanges or other equally effective devices are fitted, the vents shall be checked for leakproofness; any leaks shall be stopped by suitable means.

- (e) Blank flanges or other equally effective devices shall be fitted on vents. These closures shall be equipped with suitable seals. They shall be closed when using all elements provided for in their design types.
- (f) Lastly, a final visual check of the wagon, its equipment and marking shall be made to ensure that no filling substance is escaping.

Cover photo: Railion Nederland N.V